

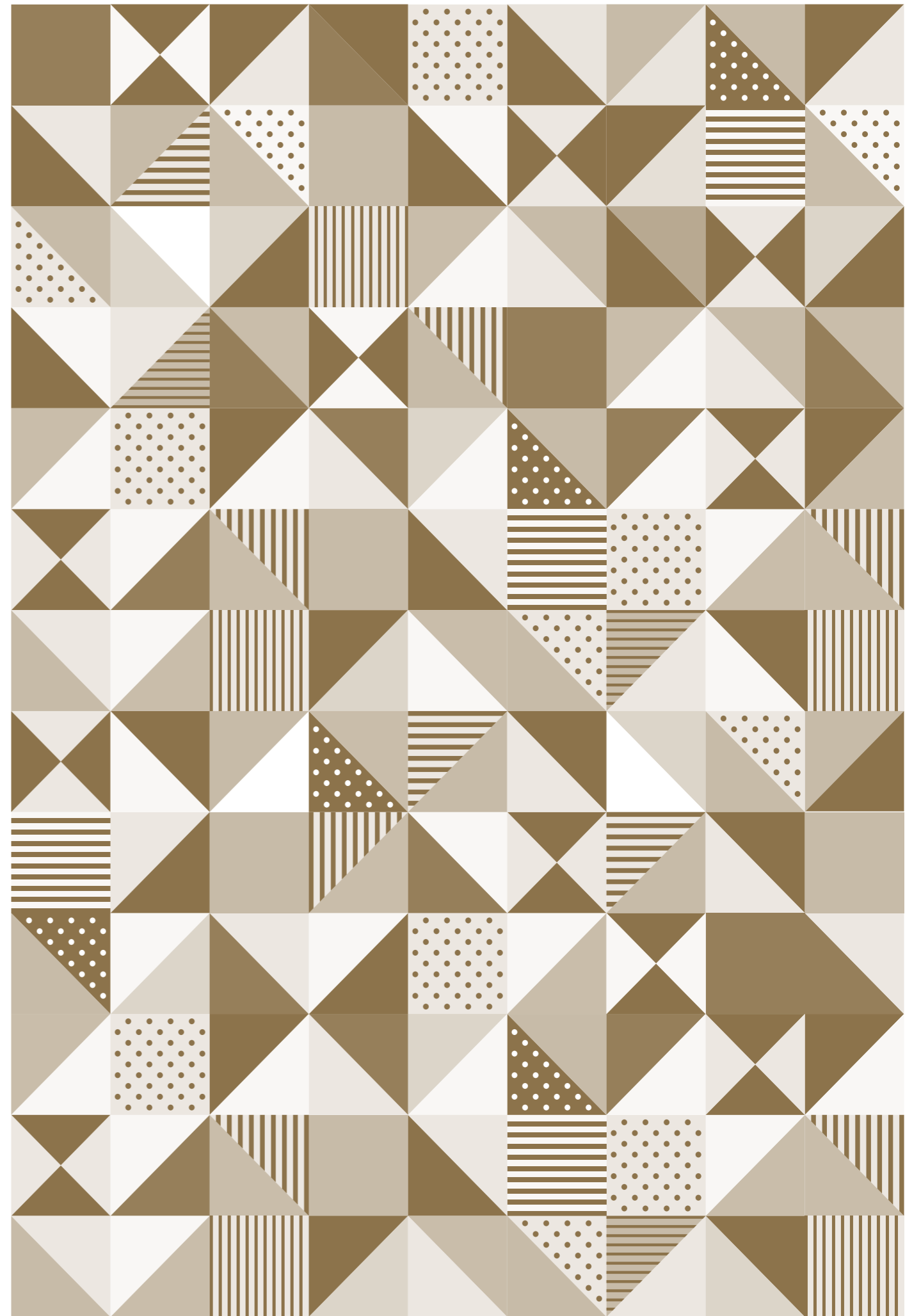

ARCHITECTURAL
HARDWARE

luxury
hotel
hardware

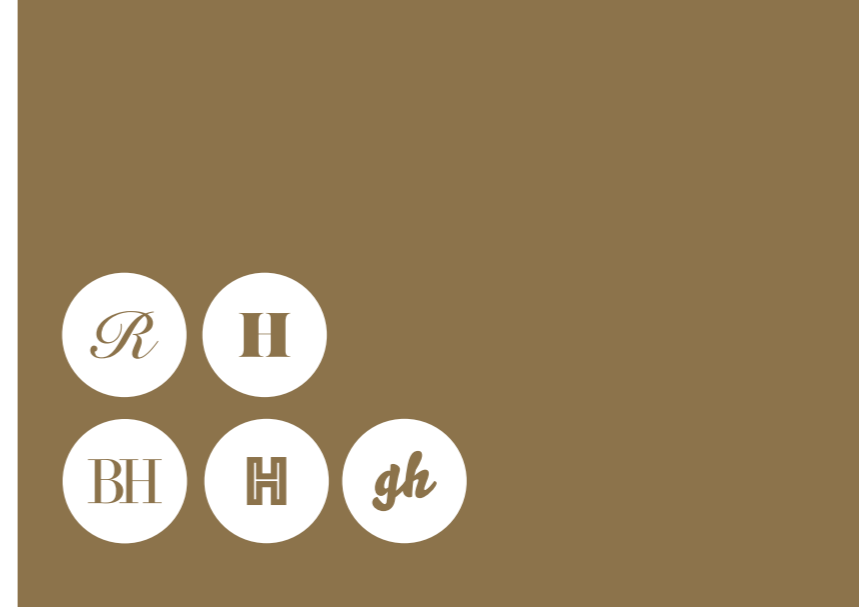



FROM SMALL TO BIG PROJECTS



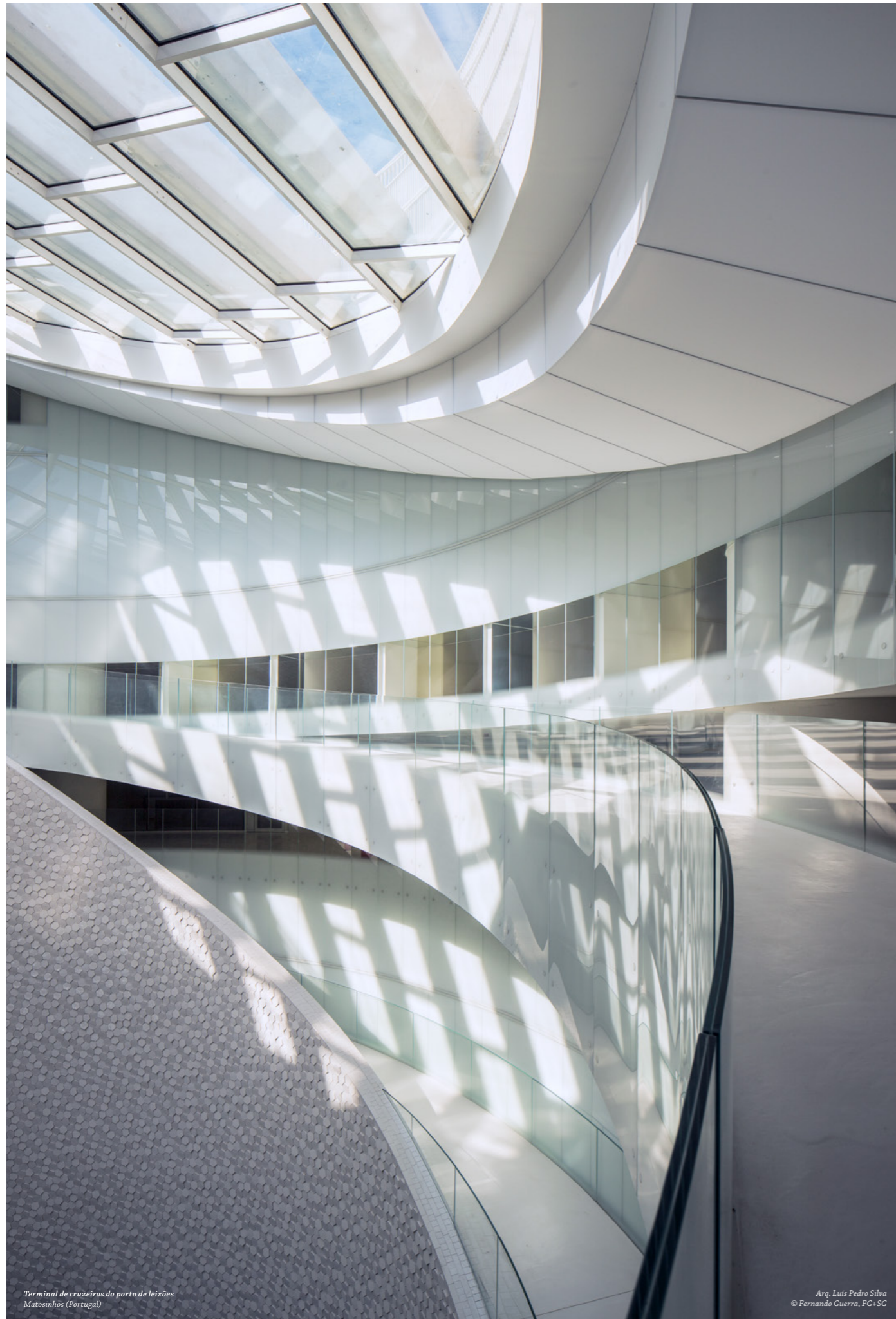

Terminal de cruzeiros do porto de leixões
Matosinhos (Portugal)

Arq. Luís Pedro Silva
© Fernando Guerra, FG+SG



A JNF sempre teve um foco especial no desenvolvimento de soluções de ferragens para hospitalidade, sempre de acordo com este exigente mercado.

Majoritariamente usamos o aço inoxidável como material, devido às características específicas da resistência à corrosão e riscos. Sendo este um material amigo do ambiente. (100% reciclável).

Para adaptar este material às tendências atuais da arquitetura / design, disponibilizamos um tratamento de superfície especial onde podemos adicionar as cores tendência como: Preto, Cobre, Ouro e Chocolate.

Este acabamento PVD TITANIUM não só adiciona cor, mas também aumenta a resistência da superfície e a resistência à corrosão, desta forma podemos fornecer facilmente ferragens para os ambientes mais agressivos como, por exemplo, hotéis no lado do mar, barcos ou spas.

Há alguns anos, abrimos um novo setor na nossa empresa, o Departamento de Sistemas de Controlo de Acessos. Juntamente com importantes empresas de software e eletrónica desenvolvemos uma série de fechaduras eletrónicas (mantendo sempre o design JNF), electrónicas adequadas para o setor de hospitalidade, onde a segurança e o conceito user-friendly estão no topo da lista.

JNF always had a special focus in hospitality solutions, developing hardware accordingly to this exigent market.

Mainly we use stainless steel material, due to the specific features like corrosion and scratch resistance, life time material and more important ecofriendly (100% recyclable material).

To make this material more suitable for the actual architecture / design tendencies we can give a special surface treatment where we can add trendy colors like Black, Copper, Gold and Chocolate.

This PVD TITANIUM finish not only adds color but also increases surface strength and corrosion resistance, this way we can easily supply hardware to the most aggressive environments like, for example, hotels in the seaside, boats or spas.

Some years ago, we opened a new sector in our company, the Access Control Systems Department. Together with important electronic and software company's we developed a range of electronic door locks (keeping the JNFdesign line), that are suitable for the hospitality sector, where the security and user-friendly concept are on the top of the list.

JNF siempre ha tenido un enfoque especial en el desarrollo de soluciones de herrajes para la hospitalidad, siempre de acuerdo con este exigente mercado.

Majoritariamente, utilizamos el acero inoxidable, debido a las características específicas de resistencia a la corrosión y al rayado y más importante porque es un material amigo del ambiente (100% reciclable).

Para adaptar este material a las tendencias actuales de la arquitectura / diseño, disponemos de un tratamiento de superficie especial, donde podemos añadir los colores de la moda, como Negro, Cobre, Oro y Chocolate.

Este acabado PVD TITANIUM no sólo añade color, pero también aumenta la resistencia de la superficie y la resistencia a la corrosión. De esta forma podemos suministrar fácilmente herrajes para los ambientes más agresivos como, por ejemplo, hoteles en a orilla del mar, barcos o spas.

Hace algunos años, abrimos un nuevo sector en nuestra empresa, el Departamento de Sistemas de Control de Acceso. Junto con importantes empresas de software y electrónica, desarrollamos una gama de cerraduras electrónicas (siempre pensando en el diseño de la línea JNF), adecuadas para el sector de la hospitalidad, donde la seguridad y lo manejo fácil se encuentran en lo tope de la lista.

different solutions for specific areas



P01

ACCESS CONTROL SOLUTIONS



08

Soluções de controlo de acessos
Soluciones de control de accesos

P02

DOOR SOLUTIONS



42

Soluções para portas
Soluciones para puertas

P03

SLIDING & FOLDING DOOR SOLUTIONS

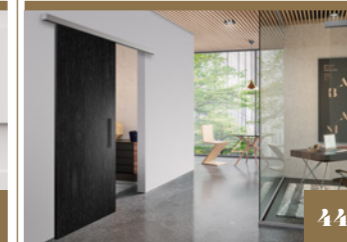

44

Soluções para portas de correr e de livro / Soluciones para puertas correderas y plegables

P04

GLASS SOLUTIONS



48

Soluções para vidro
Soluciones para cristal

P05

CLOSET SOLUTIONS

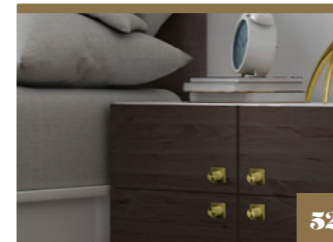

52

Soluções para armários
Soluciones para armarios

P06

SHOWER SOLUTIONS



54

Soluções para cabines de banho
Soluciones para cabinas de ducha

P07

BATHROOM SOLUTIONS



58

Soluções para casa de banho
Soluciones para el baño

P08

WASHROOM SOLUTIONS



66

Soluções para áreas públicas
Soluciones para áreas públicas

P09

SIGNAGE SOLUTIONS



72

Soluções para sinalética
Soluciones de señalización

P10

EXIT & SECURITY SOLUTIONS

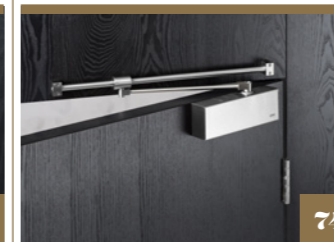

74

Soluções para saídas de emergência e segurança.
Soluciones de salida y seguridad

VOYAGER

— ACCESS CONTROL SYSTEMS —

Controle a sua porta em qualquer lugar do mundo

Sistema de controlo de acessos dedicados à hotelaria e alojamento local. Nunca foi tão fácil gerir o acesso e a segurança com diferentes soluções, para alojamentos locais, hotéis e até mesmo casas privadas. Tudo na palma da sua mão. Ofereça uma experiência de check-in sem complicações.

Control your door from any place in the world

Access control system dedicated to hotels and local accommodation. It has never been easier to manage access and security with different solutions, for local rentals, hotels and even private homes. Everything in the palm of your hand. Offer a hassle-free check-in experience.

Controla tu puerta de cualquier lugar del mundo.

Sistema de control de accesos dedicados a hotelaria y alojamiento local. Nunca ha sido tan fácil gestionar el acceso y la seguridad con diferentes soluciones, para alquileres, hoteles e incluso viviendas particulares. Todo en la palma de su mano. Ofrece una experiencia de check-in sin complicaciones.



Manage your hotel with complete security

Com o Sistema VOYAGER não tem de se preocupar com a segurança, todo o sistema de controlo de acesso está dotado com os mais avançados recursos tecnológicos. Podendo serem geridos numa rede fechada autónoma LAN.

With the VOYAGER System you don't have to worry about security. The entire access control system is equipped with the most advanced technological resources. They can be managed in a closed autonomous LAN network.

Con el Sistema VOYAGER no tienes que preocuparte por la seguridad. Todo el sistema de control de acceso está equipado con los recursos tecnológicos más avanzados. Se pueden gestionar en una red LAN autónoma cerrada.



Declaração de conformidade

Descrição dos testes realizados:
Todos as comunicações realizadas entre o dispositivo e o servidor dispõem de certificado válido com uma força de encriptação SHA-256 emitido pela entidade Lets Encrypt. Todas as passwords comunicadas e armazenadas são encriptadas usando uma comunicação md5 + secretkey.

Os testes realizados de captura de pacotes foram realizados usando dispositivo sophos XGS135 v2 que nos permitiu validar que nenhum trafego intersectado está comprometido.

Em relação ao armazenamento local dos dispositivos, após leitura dos chips internos foi concluído que não é possível aceder a informação de impressão digital se não dispormos de um certificado prévio.

A informação armazenada online, está protegida por certificados e métodos MFA, armazenado em data center com certificações ISO 27001 e proteções DDos, Firewall e redes redundantes.

Conformity declaration

Description of the tests performed:
All communications carried out between the device and the server have a valid certificate with SHA-256 encryption strength issued by Lets Encrypt. All communicated and stored passwords are encrypted using md5 + secretkey communication.

The packet capture tests carried out were carried out using a Sophos XGS135 v2 device, which allowed us to validate that no intersected traffic was compromised.

Regarding the devices' local storage, after reading the internal chips it was concluded that it is not possible to access fingerprint information if we do not have a prior certificate.

The information stored online is protected by certificates and MFA methods, stored in a data center with ISO 27001 certifications and DDos, Firewall and redundant network protections.

Declaración de conformidad

Descripción de las pruebas realizadas:
Todas las comunicaciones realizadas entre el dispositivo y el servidor cuentan con un certificado válido con nivel de cifrado SHA-256 emitido por Lets Encrypt. Todas las contraseñas comunicadas y almacenadas se cifran mediante comunicación md5 + llave secreta.

Las pruebas de captura de paquetes realizadas se realizaron utilizando un dispositivo Sophos XGS135 v2, lo que permitió validar que ningún tráfico intersectado estuviera comprometido.

Respecto al almacenamiento local de los dispositivos, tras leer los chips internos se concluyó que no es posible acceder a la información de la huella si no contamos con un certificado previo.

La información almacenada en línea está protegida mediante certificados y métodos MFA, almacenada en un centro de datos con certificaciones ISO 27001 y protecciones DDos, Firewall y red redundante.

VOYAGER

ACCESS CONTROL SYSTEMS

CONTROL YOUR DOOR FROM ANY PLACE IN THE WORLD

CONTROLE A SUA PORTA EM QUALQUER LUGAR DO MUNDO / CONTROLA TU PUERTA DE CUALQUIER LUGAR DEL MUNDO.

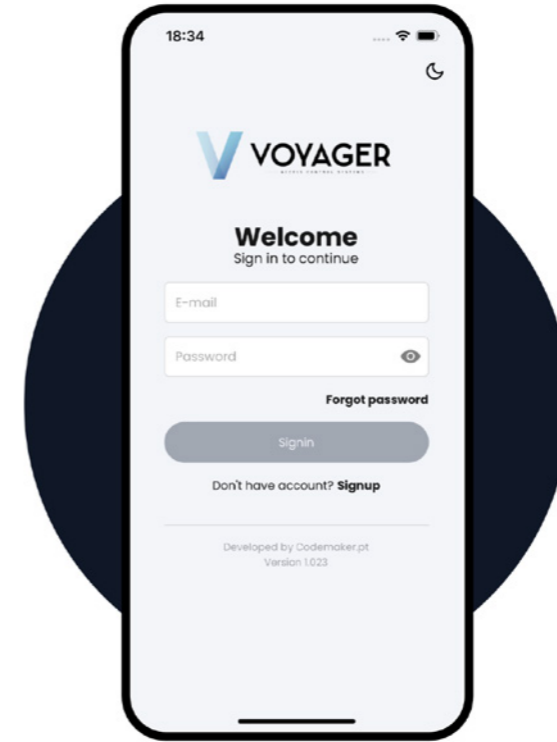

Novas funcionalidades que fazem a diferença!

Nunca foi tão fácil gerir o acesso e a segurança com diferentes soluções, para arrendamentos, hotéis e até mesmo casas privadas. Tudo na palma da sua mão. Ofereça uma experiência de check-in sem complicações.

New features that make the difference!

It has never been easier to manage access and security with different solutions, for rentals, hotels and even private homes. Everything in the palm of your hand. Offer a hassle-free check-in experience.

Nuevas características que marcan la diferencia!

Nunca ha sido tan fácil gestionar el acceso y la seguridad con diferentes soluciones, para alquileres, hoteles e incluso viviendas particulares. Todo en la palma de su mano. Ofrece una experiencia de check-in sin complicaciones.



NFC Card
Use your smartphone NFC to create new cards.



Virtual Key
Create and send a virtual keys.

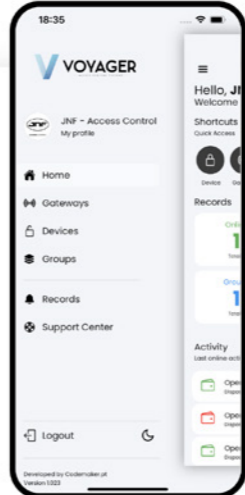



Status
Check the device status contributing to a secure and error free experience.



WEB
Now also available for your desktop.

VOYAGER

ACCESS CONTROL SYSTEMS

Total controlo sobre os dispositivos.

Possibilidade de criar diversos sistemas de acesso, através de PIN, Cartão, Virtual Key ou Impressão Digital. Possível partilhar os dispositivos com outros utilizadores.

Full control over devices.

Possibility of creating different access systems, using PIN, Card, Virtual Key or Fingerprint. Possible to share devices with other users.

Control total sobre los dispositivos.

Posibilidad de crear diferentes sistemas de acceso, mediante PIN, Tarjeta, Clave Virtual o Huella. Posible de compartir dispositivos con otros usuarios.

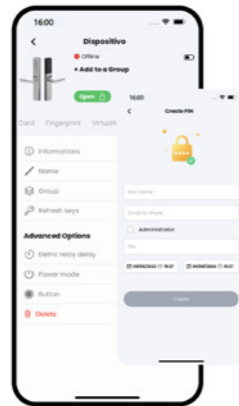

Full control over devices

Possibility of creating different access systems, using PIN, Card, Virtual Key or Fingerprint. You can also share devices with other users.

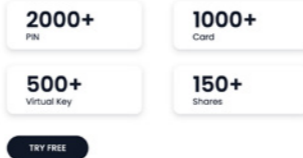

Minimal Interface.

Todas as funcionalidades foram desenhadas para serem simples e intuitivas para os usuários, fáceis de interpretar sem necessidade de formações nem manuais. Aplicação disponível em diferentes interfaces: APP para Smartphone, Tablet e URL para qualquer dispositivo.

Minimal interface

All features were designed to be simple and intuitive for users, easy to interpret without the need for training or manuals. Application available on different interfaces: APP for Smartphone, Tablet and URL for any device.

Interfaz mínima.

Todas las funciones fueron diseñadas para ser sencillas e intuitivas para los usuarios, fáciles de interpretar sin necesidad de formación ni manuales. Aplicación disponible en diferentes interfaces: APP para Smartphone, Tablet y URL en cualquier dispositivo.

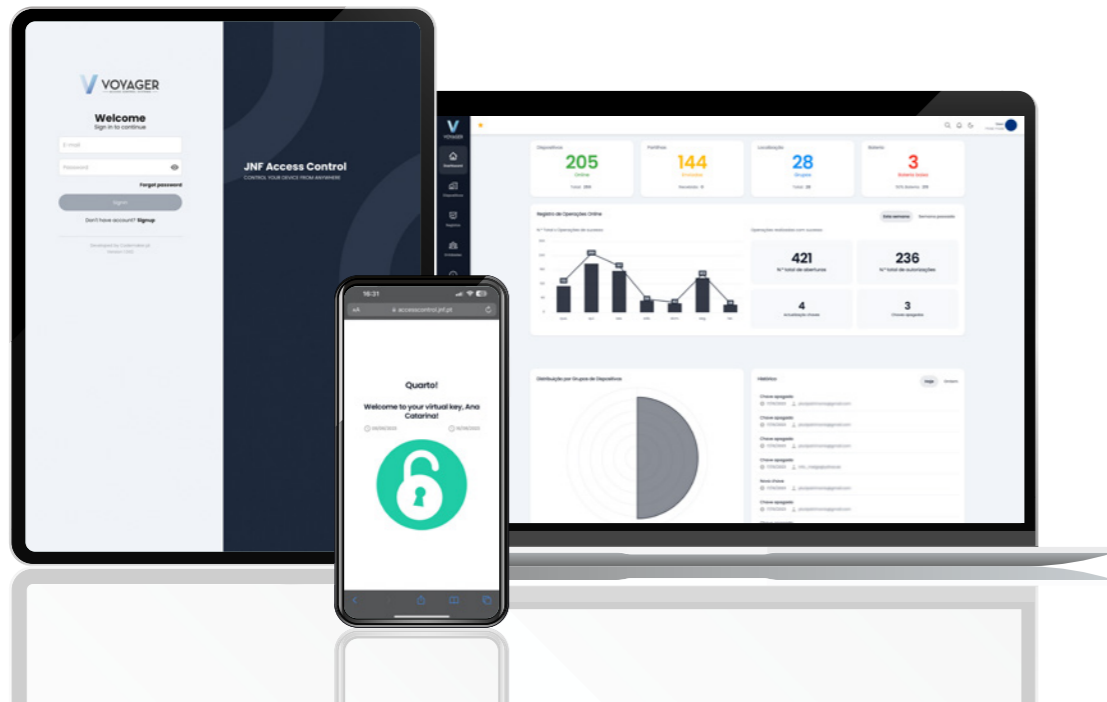

Funcionalidades interactivas.

Funcionalidades que o vão ajudar no dia a dia, na gestão de todos os dispositivos.

Interactive features.

Features that will help you in your day to day management of all devices.

Funcionalidades interactivo.

Funciones que te ayudarán en tu vida diaria, en la gestión de todos tus dispositivos.

Interactive features

Features that will help you in your day to day management of all devices.

- Online Registrations**
Consult all operations performed.
- Support Center**
Please visit our support center for any queries regarding all devices.
- Groups**
Organize your devices into different groups that are fully managed by you.

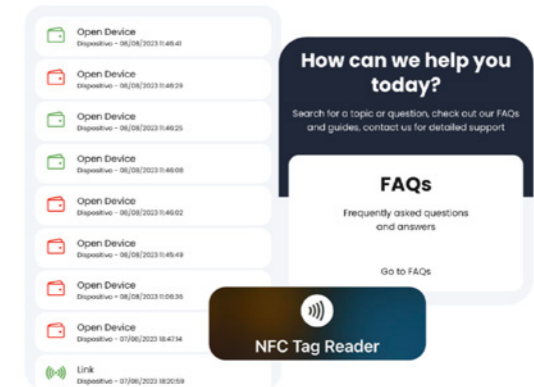

Registos Online
Consulte todas as operações realizadas.

Centro de Suporte
Visite o centro de suporte para esclarecer qualquer questão relacionada com todos os dispositivos.

Grupos
Organize os seus dispositivos em diferentes grupos totalmente geridos por si.

NFC
Use NFC para registrar seus cartões ou use seu telefone para abrir a porta.

Online Registrations
Consult all operations performed.

Support Center
Please visit our support center for any queries regarding all devices.

Groups
Organize your devices into different groups that are fully managed by you.

NFC
Use NFC to register your cards or use your phone to open the door.

Inscripciones en línea
Consultar todas las operaciones realizadas.

Centro de Apoyo
Visita el centro de soporte para cualquier consulta relacionada con todos los dispositivos.

Grupos
Organiza tus dispositivos en diferentes grupos completamente gestionado por ti.

NFC
Utilice NFC para registrar sus tarjetas o su teléfono para abrir la puerta.





The future is wireless.

Com o Sistema VOYAGER não é necessária a ligação por cabos para o controlo em tempo real dos dispositivos.

With the VOYAGER System is no longer required to wire network to have real time control on the devices

Con el Sistema VOYAGER No es necesario cablear para controlar en tiempo real los dispositivos.

VOYAGER — ACCESS CONTROL SYSTEMS —

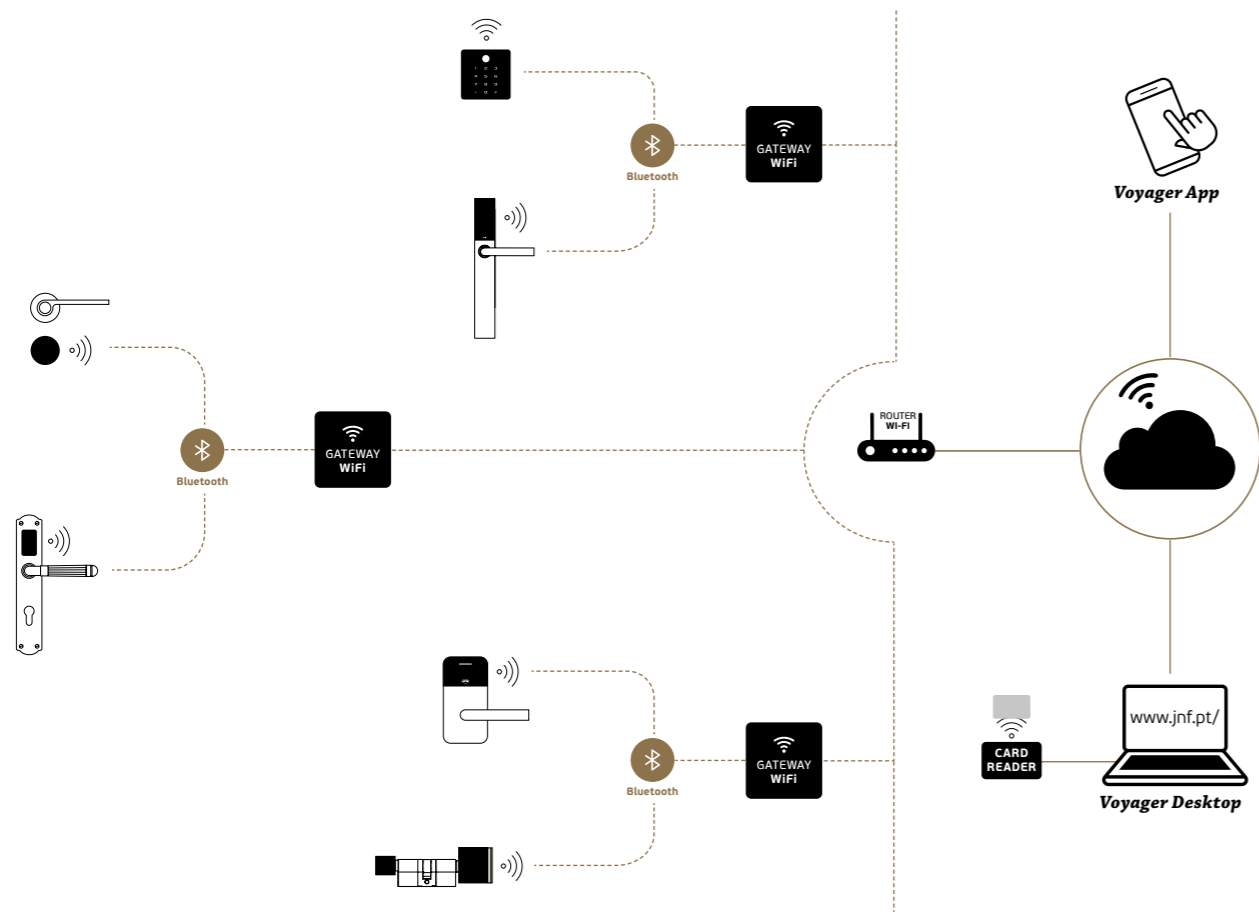

CITY
IN.27.500

MAXIM
IN.27.400



WALL CONTROL V1
IN.27.420

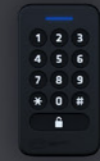

WALL CONTROL V2
IN.27.520



ART DECO
IN.27.300

SKY
IN.20.602



DRESS CODE
IN.27.350



S90 - S-TRONIC
IN.19.590



BILLY
IN.27.501



MOBIL GUARD
IN.28.120

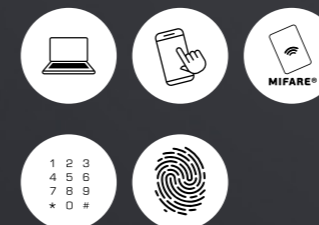

Total controlo sobre os dispositivos.

Full control over devices.

Control total sobre los dispositivos.



VOYAGER

C O R P O R A T E

THE ACCESS CONTROL SOLUTION FOR HOTEL MANAGEMENT

A SOLUÇÃO PARA GESTÃO HOTELEIRA DE CONTROLO DE ACESSOS LA SOLUCIÓN PARA LA GESTIÓN HOTELERA DE CONTROL DE ACCESO.



A hotelaria está cada vez mais ligada à tecnologia para uma melhor gestão e controlo de acessos.

A JNF desenvolveu um software pensado para a indústria hoteleira, com o objetivo de garantir mais segurança, conforto e acessibilidade a grande parte dos serviços disponíveis no hotel.

O software VOYAGER Corporate pode ser fornecido com um servidor local, para garantir maior segurança e autonomia na gestão de acessos, assim como uma série de serviços customizados à medida de cada hotel.

Múltiplos serviços estarão disponíveis no smartphone de cada hóspede a partir da VOYAGER Corporate. Esta aplicação está preparada para estabelecer uma ligação direta entre o hóspede e o hotel. Um maior conforto e rapidez nos pedidos mais exigentes de um hóspede.

The hotel industry is increasingly linked to technology for better management and access control.

JNF developed software designed for the hotel industry, with the aim of ensuring greater security, comfort and accessibility to most of the services available at the hotel.

The VOYAGER Corporate software can be supplied with a local server, to guarantee greater security and autonomy in access management, as well as customized services tailored to each hotel.

Multiple services will be available on each guest's smartphone using the VOYAGER Corporate. This application is prepared to establish a direct connection between the guest and the hotel. Greater comfort and speed when dealing with a guest's most demanding requests.

La industria hotelera está cada vez más ligada a la tecnología para una mejor gestión y control de accesos.

JNF desarrolló un software diseñado para la industria hotelera, con el objetivo de garantizar mayor seguridad, comodidad y accesibilidad a la mayoría de los servicios disponibles en el hotel.

Lo software VOYAGER Corporate puede suministrarse con un servidor local, para garantizar una mayor seguridad y autonomía en la gestión de accesos, así como una serie de servicios personalizados y adaptados a cada hotel.

Múltiples servicios estarán disponibles en lo smartphone de cada huésped utilizando la VOYAGER Corporate App. Esta aplicación está preparada para establecer una conexión directa entre el huésped y lo hotel. Mayor comodidad y rapidez a la hora de atender las peticiones más exigentes del huésped.





Voyager Corporate,
O software que para além de
controlar os acessos, também
vai gerir pessoas e serviços,
dedicados à indústria
hoteleira.

Voyager Corporate,
The software, in addition
to access control, will also
manage people and services,
a series of features dedicated
to the hotel industry.

Voyager Corporate,
Lo software, además del control
de acceso, también gestionará
personas y servicios, una serie
de funcionalidades dedicadas
al sector hotelero.

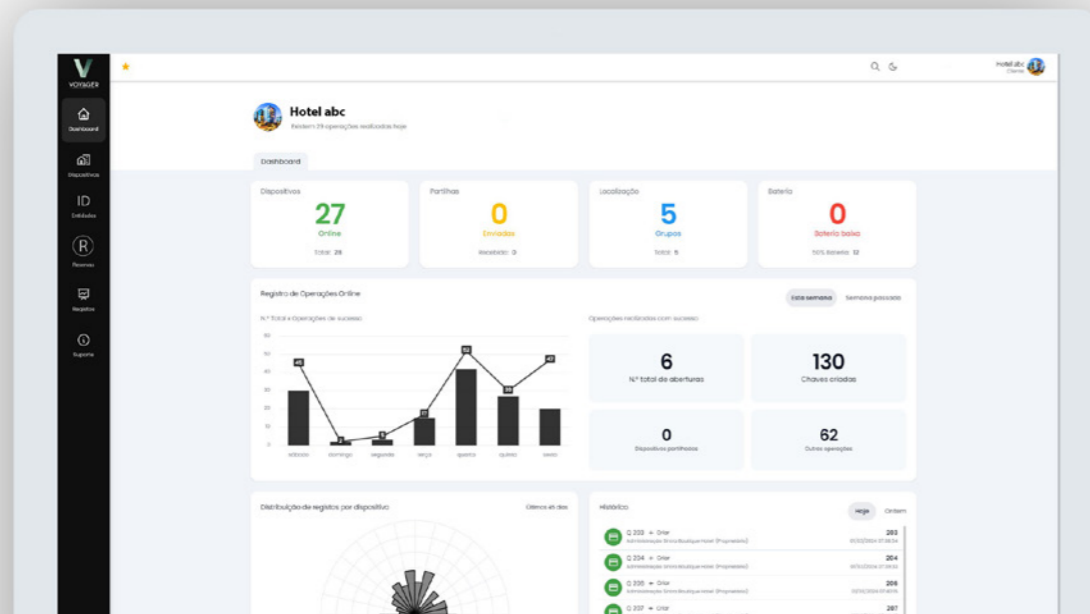

Os Sistema de controlo de acesso VOYAGER Corporate para além de gerir portas evoluiu para um outro sistema de gestão de operações da indústria hoteleira sem depender da ligação à internet. Numa rede fechada para garantir maior segurança e autonomia na gestão de acessos.

Focado em fornecer as melhores experiências aos hóspedes e uma melhor gestão para os profissionais de hotelaria.

O software Voyager Corporate está pensado para os diferentes perfis de utilizadores, com o objectivo de estabelecer uma maior comunicação entre os diversos departamentos e a gestão de hotel. O software está desenvolvido para gerir acessos, serviços e os recurso humanos.

No modo gestão de hotel estão todas as funcionalidades disponíveis e asseguradas para que possa ter um controlo sobre as entradas nas diferentes áreas do hotel. Com o software Voyager Corporate é possível fazer uma gestão de todas as áreas de acesso no hotel em tempo real.

The VOYAGER Corporate access control system, in addition to managing doors, has evolved into another operations management system for the hotel industry, without depending on the internet connection. In a closed network to guarantee greater security and autonomy in access management.

Focused on offering the best experiences to guests and better management for hospitality professionals.

The Voyager software is designed for different types of users, with the aim of establishing greater communication between the different areas. The software has dedicated areas for hotel management.

In hotel management mode, all features are available so that you can have control over the management of employees as well as services.

The Voyager Corporate software makes it possible to manage all access areas in hotel in the real time.

El sistema de control de accesos VOYAGER Corporate, además de gestionar puertas, ha evolucionado hasta convertirse en un sistema más de gestión de operaciones para la industria hotelera, sin depender de la conexión a internet. En red cerrada para garantizar mayor seguridad y autonomía en la gestión de accesos.

Enfocados en ofrecer las mejores experiencias a los huéspedes y una mejor gestión a los profesionales de la hostelería.

el software Voyager está diseñado para 3 tipos diferentes de usuarios, con el objetivo de establecer una mayor comunicación entre las distintas áreas. El software cuenta con áreas dedicadas a la gestión hotelera.

En el modo de gestión del hotel, todas las funciones están disponibles. Para que puedas tener control sobre la gestión de empleados así como de los servicios.

El software Voyager Corporate permite gestionar en tiempo real todas las zonas de acceso del hotel.

Solution 1 LAN connections VOYAGER CORPORATE

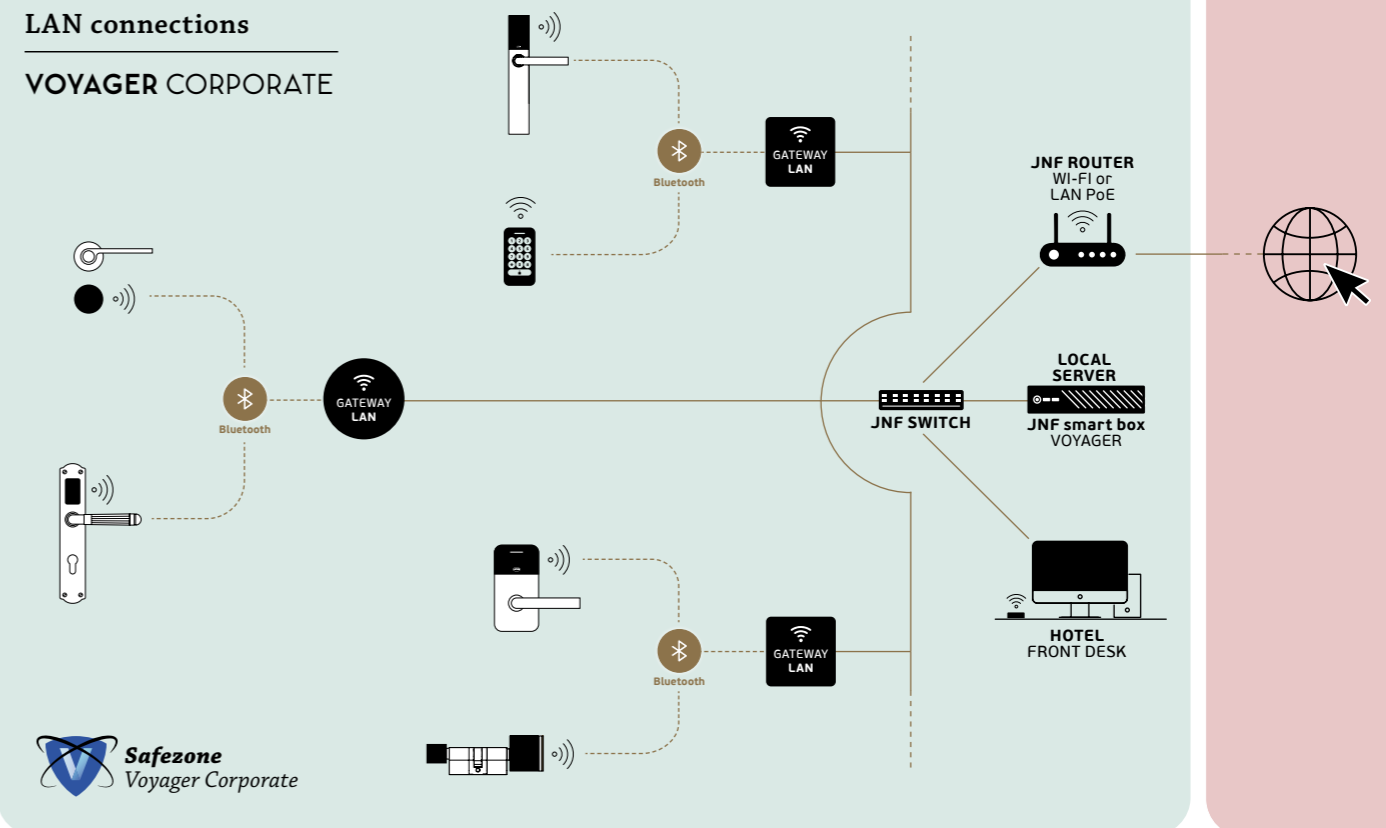



A experiência dos utilizadores com os recursos móveis é cada vez mais usual, cómoda e rápida.

Esta nova tecnologia de controlo de acesso, para além de garantir entradas no quarto de hotel, pode também ser usada para fazer o agendamento de outros serviços disponibilizados pelo hotel, tais como, acesso ao spa, serviço de pequeno-almoço, ou mesmo o check-out tardio. Todos estes serviços podem ser notificados e compilados em relatórios mensais para análise de ocupação assim como performance de serviços. Estes são exemplos do que será possível gerir com este novo software.

Todos os serviços disponíveis na palma da mão, para uma experiência mais confortável. Um serviço de gestão hoteleira que lhe dá a flexibilidade e a fiabilidade de que necessita, sem comprometer a segurança do seu hotel.

User experiences with mobile resources are increasingly common, comfortable and fast.

This new access control technology, in addition to guaranteeing entrances to the hotel room, can also be used to schedule other services available at the hotel, such as access to the spa, breakfast service, or even a late check-out. All these services can be notified and compiled into monthly reports to analyze occupancy as well as service performance. These are examples of what will be possible to manage with this new software.

All services available in the palm of your hand, for a more comfortable experience. A hotel management service that gives you the flexibility and reliability you need, without compromising the security of your hotel.

Las experiencias de usuario con recursos móviles son cada vez más habituales, cómodas y rápidas.

Esta nueva tecnología de control de accesos, además de garantizar las entradas a la habitación del hotel, también se puede utilizar para programar otros servicios disponibles en el hotel, como el acceso al spa, el servicio de desayuno o incluso un late check-out. Todos estos servicios se pueden notificar y compilar en informes mensuales para analizar la ocupación y el desempeño del servicio. Estos son ejemplos de lo que será posible gestionar con este nuevo software.

Todos los servicios disponibles en la palma de tu mano, para una experiencia más cómoda. Un servicio de gestión hotelera que te brinda la flexibilidad y confiabilidad que necesitas, sin comprometer la seguridad de tu hotel.

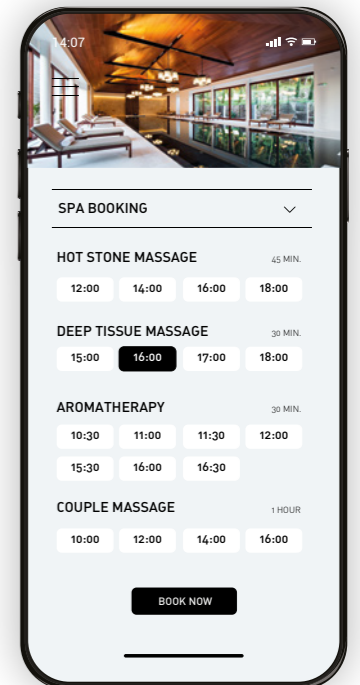
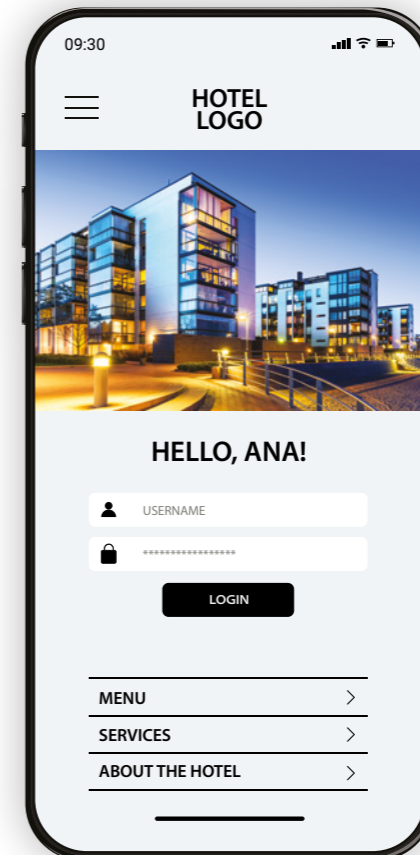
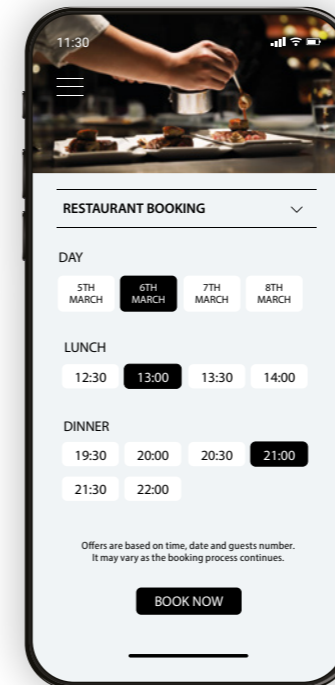



**Tudo num só lugar,
Economize o tempo de gestão
do seu staff.**

**Área dedicada à gestão dos
recurso humanos,
com monitorização de
serviços como limpeza,
recepção e manutenção.**

- Diferentes tipos de permissões de acesso às diferentes áreas do hotel.
- Todos os registos de entradas por parte dos usuários / Staff interno.
- Controlo do estado de limpeza dos quartos.
- Emissão automática de serviço de limpeza após check-out do hospede.

**All in one place,
Save time managing
your staff.**

**Area dedicated to human
resources management, with
monitoring of services such
as cleaning, reception and
maintenance.**

- Different types of access permissions to different areas of the hotel.
- Access to all entry records for internal users.
- Control of the cleanliness of the rooms.
- Automatic issuance of cleaning service after guest check-out.

**Todo en un solo lugar,
Ahorre tiempo administrando
a su personal.**

**Área dedicada a la gestión
de recursos humanos,
con seguimiento de servicios
como limpieza, recepción y
mantenimiento.**

- Diferentes tipos de permisos de acceso a diferentes zonas del hotel.
- Acceso a todos los registros de entrada para usuarios internos.
- Control de la limpieza de las habitaciones.
- Emisión automática del servicio de limpieza después del check-out del huésped.

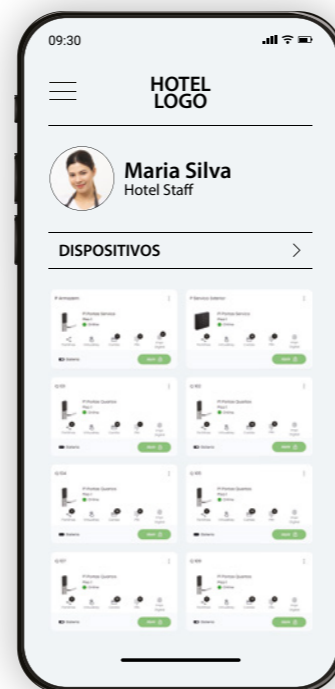
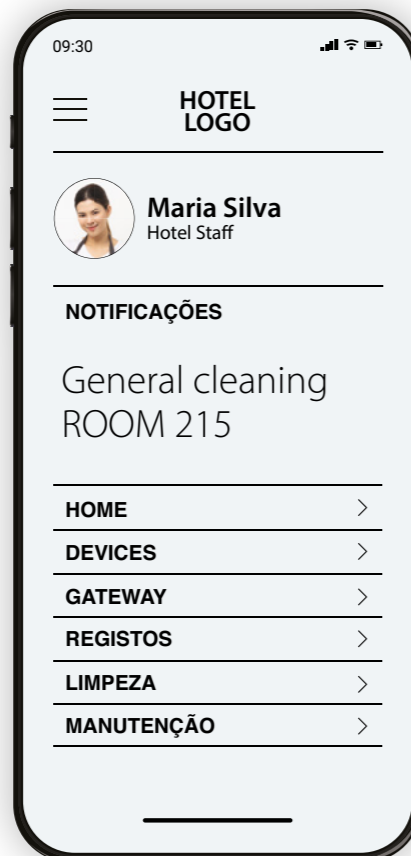
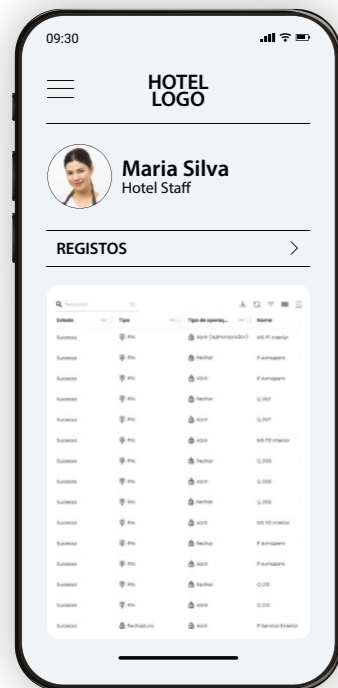

MAXIM

FULL LINKAGE CONNECTION
ACCESS CONTROL
SYSTEM

A Fechadura eletrónica de controlo de acessos mais polivalente, combina diversas tecnologias de abertura, smartphone, bluetooth, teclado numérico, tecnologia MIFARE e impressão digital.

The most versatile electronic access control lock, combines several opening technologies, Smartphone, Bluetooth, keyboard, MIFARE technology and digital printing.

La cerradura electrónica de control de accesos más versátil, combina varias tecnologías de apertura, Smartphone, Bluetooth, teclado, tecnología MIFARE e huella digital.



MAXIM
IN.27.400.A +
IN.00.452.N.SR + IN.20.601.R



MAXIM
IN.27.400.A.TG +
IN.00.452.N.SR.TG + IN.20.601.R



IN.27.400.A + IN.00.452.N.SR
Satinado / Satin



IN.27.400.A.TB + IN.00.452.N.SR.TB
PVD Titanium Black



IN.27.400.A.TG + IN.00.452.N.SR.TG
PVD Titanium Gold



IN.27.400.A.TCO + IN.00.452.N.SR.TCO
PVD Titanium Copper



IN.27.400.A.TCH + IN.00.452.N.SR.TCH
PVD Titanium Black



IN.27.400.A.TMS + IN.00.452.N.SR.TMS
PVD Titanium JNF MICROSAFE™



CITY

THE ACCESS CONTROL SYSTEM

Com um desenho simples, o controlo de acessos CITY destaca-se pela grande compatibilidade com diferentes fechaduras, diversidade de acabamentos e modelos de puxadores. Nasce como segunda geração de um sistema JNF muito fiável e robusto.

CITY With a simple design, the CITY access control stands out for its great compatibility with different locks, diversity of finishes and handle models. It was born as the second generation of a very reliable and robust JNF system.

Con un diseño simple, el control de accesos CITY se destaca pela grande compatibilidad con diferentes cerraduras, diversidad de acabados y modelos de manillas. Nace como segunda generación de un sistema JNF muy confiable y robusto.



CITY
IN.27.500.A.W +
IN.00.177.SR + IN.20.601.R



IN.27.500.A + IN.00.412.SR
Satinado / Satin



IN.27.500.A.TB + IN.00.412.TB.SR
PVD Titanium Black



IN.27.500.A.TG + IN.00.412.TG.SR
PVD Titanium Gold



IN.27.500.A.TCO + IN.00.412.TCO.SR
PVD Titanium Copper



IN.27.500.A.TCH + IN.00.412.TCH.SR
PVD Titanium Chocolate



IN.27.500.A.TMS + IN.00.412.TMS.SR
PVD Titanium JNF MICROSAFE™



BILLY

THE QUICK ACCESS CONTROL SYSTEM

A solução JNF mais fácil de instalar, converte facilmente uma porta operada por chave numa versão de controlo de acesso. Flexibilidade de acabamentos e modelos de puxadores.

The easiest JNF solution for installation, easily converts a key-operated door into an access control version. Flexibility of finishes and lever handle models

La solución JNF más fácil de instalar, convierte fácilmente una puerta operada con llave en una versión de control de acceso. Flexibilidad de acabados y modelos de manillas



SKY SYSTEM

FULL ACCESS CONTROL
LESS VISUAL
IMPACT

Sistema que combina mecânica e eletrônica numa fechadura de embutir, ficando visível apenas o puxador e leitor de cartão /

System that combines mechanical and electronics in a mortise lock, only the handle and card reader are visible /

Sistema que combina mecânica y electrónica en una cerradura de embutir, sólo se queda visible la manilla y el lector de tarjeta.

WWW.JNF.PT



POI Access Control Solutions

LUXURY HOTEL HARDWARE



SKY
IN.20.602 +
IN.00.145.16.RC08M + IN.04.28R.Y08N + IN.19.S11



SKY
IN.20.602.TB +
IN.00.241.TB

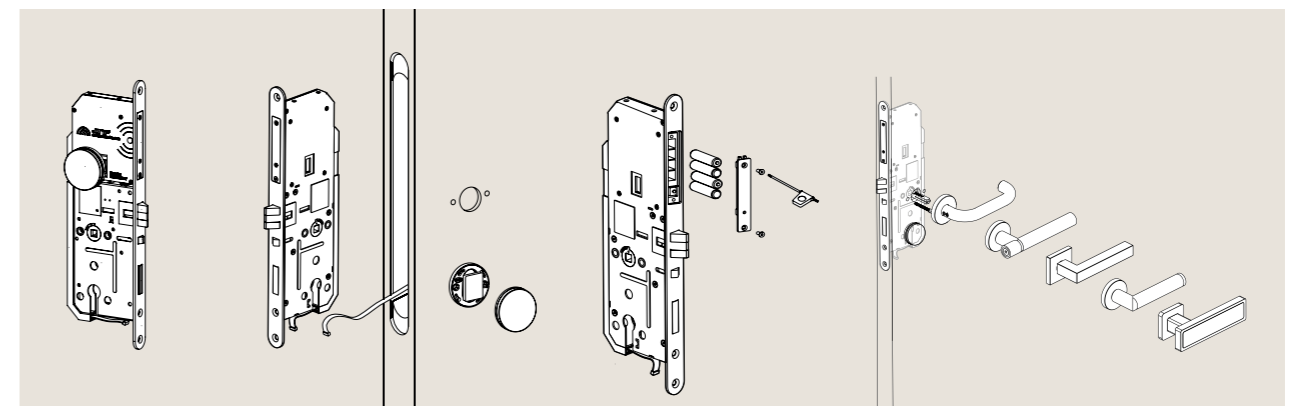

Sistema integrado de fechadura mecânica e eletrônica / Integrated system with mechanical and electronic lock / Sistema integrado de cerradura mecánica y electrónica.

Instalação simplificada, o sistema SKY é instalado da mesma forma que uma fechadura de embutir / Simplified installation, the SKY system is installed the same way as a normal mortise lock / Instalación simplificada, el sistema SKY empotrará instalado de la misma forma que una cerradura de embutir.

Sistema auto alimentado com baterias AAA. A porta não necessita de ser eletrificada. / Self powered system with AAA batteries. The door don't need to be electrified / Sistema auto alimentado con baterias AAA. La puerta no necessita de ser eletrificada.

Compatível com qualquer modelo de puxador JNF / Suitable with any JNF lever handle / Compatible con cualquier modelo de manilla JNF.



plug and play



easy to install



APPLICABLE WITH 98% JNF LEVER HANDLE MODEL

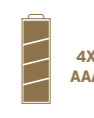

4X AAA



CE

DRESS CODE

THE LUXURY AND SOPHISTICATION
ACCESS CONTROL
SYSTEM

Crie o outfit perfeito para o sistema de controlo de acesso. Luxuoso e sofisticado pode ser personalizado a cada projecto.

Create the perfect outfit for your access control system. Luxurious and sophisticated, it can be customized for each project.

Crea el outfit perfecto para tu sistema de control de acceso. Lujoso y sofisticado, se puede personalizar para cada proyecto.



DRESS CODE
IN.27.350.N.TG + IN.00.145.LN.TG + IN.19.S40.TG



DRESS CODE
IN.27.350.N + IN.00.145.LN + IN.19.S40



DRESS CODE
IN.27.350.B + IN.00.145.LN + IN.19.S40



DRESS CODE
IN.27.350.C + IN.00.145.LN + IN.19.S40

DRESS CODE
IN.27.350.C
IN.00.145.LN



ART DECO

THE TIMELESS
ACCESS CONTROL
SOLUTION

A coleção de controlo de acesso ART DECO foi cuidadosamente desenhada para que possa integrar hotéis com caris mais clássico.

The collection ART DECO access control was carefully designed so that it can integrate hotels with a more classic character.

La colección de controles de acceso ART DECO fue cuidadosamente diseñada para que pueda integrar hoteles con un carácter clásico.



ART DECO PARIS
IN.27.300



ART DECO NEW YORK
IN.27.323



ART DECO BRUGES
IN.27.316



ART DECO FRENCH
IN.27.309



GATEWAY
IN.27.422



ART DECO PARIS

Fechadura electrónica motorizada, com leitor / Motorized electronic lock with reader / Cerradura electrónica motorizada con lector.



ART DECO NEW YORK

Fechadura electrónica motorizada, com leitor / Motorized electronic lock with reader / Cerradura electrónica motorizada con lector.



ART DECO BRUGES

Fechadura electrónica motorizada, com leitor / Motorized electronic lock with reader / Cerradura electrónica motorizada con lector.



ART DECO FRENCH

Fechadura electrónica motorizada, com leitor / Motorized electronic lock with reader / Cerradura electrónica motorizada con lector.

WALL CONTROL V1

FULL LINKAGE CONNECTION
ACCESS CONTROL
SYSTEM

Controlo de acessos mural que combina diversas tecnologias de abertura, Bluetooth, smartphone, teclado numérico, tecnologia MIFARE e impressão digital. Permite controlar diversos tipos de periféricos.

Wall access control that combines several opening technologies, Bluetooth, smartphone, numeric keypad, MIFARE technology and digital printing. Allows to control different types of peripherals.

Control de accesos de pared que combina varias tecnologias de apertura, Bluetooth, smartphone, teclado numérico, tecnologia MIFARE e huella digital. Permite controlar diferentes tipos de periféricos.



WALL CONTROL
IN.27.420



GATEWAY
IN.27.422

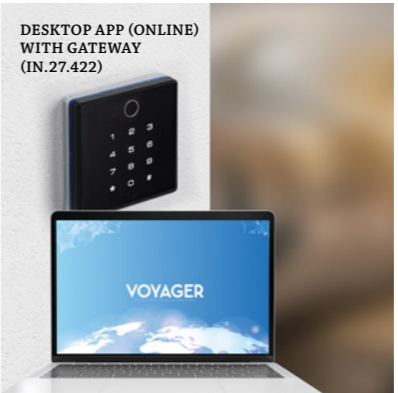
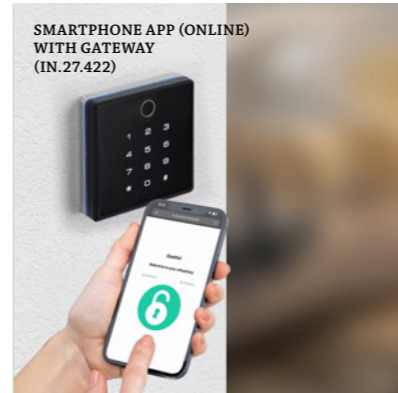
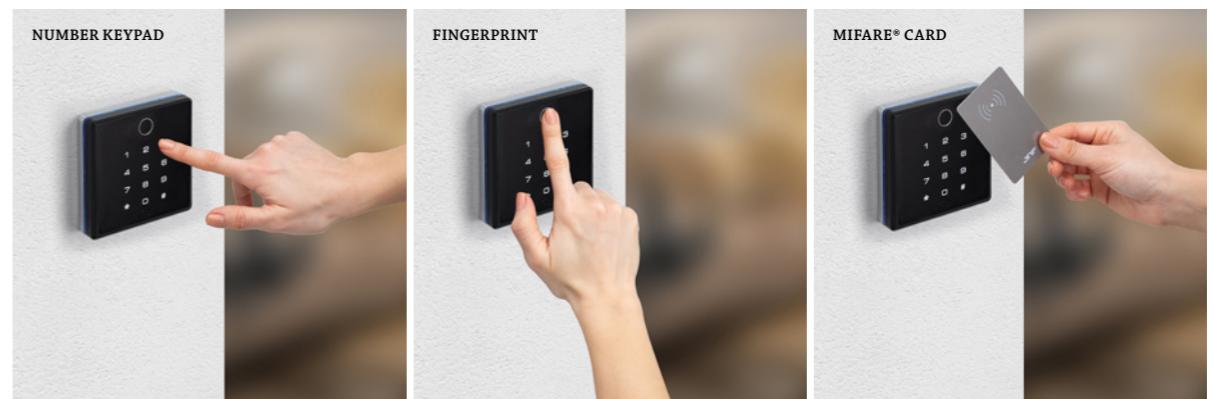

WALL CONTROL V2

FULL LINKAGE CONNECTION
ACCESS CONTROL
SYSTEM

Controlo de acessos mural que combina diversas tecnologias de abertura, Bluetooth, smartphone, teclado numérico e tecnologia MIFARE. Permite controlar diversos tipos de periféricos.

Wall access control that combines several opening technologies, Bluetooth, smartphone, numeric keypad and MIFARE technology. Allows to control different types of peripherals.

Control de accesos de pared que combina varias tecnologias de apertura, Bluetooth, smartphone, teclado numérico y tecnología MIFARE. Permite controlar diferentes tipos de periféricos.



WALL CONTROL V2
IN.27.520
SMARTPHONE APP (ONLINE)
WITH GATEWAY

FREE GLASS

ACCESS CONTROL SYSTEM FOR GLASS DOORS

O controlo de acessos em todos os departamentos mesmo em portas de vidro.

The access control in all departments, even at glass doors.

El control de acceso en todos los departamentos, incluso en puertas de vidrio.



FREE GLASS
IN.27.200.KE.TB



FREE GLASS
IN.27.200.KE.TG



FREE GLASS
IN.27.200.KE.TCO

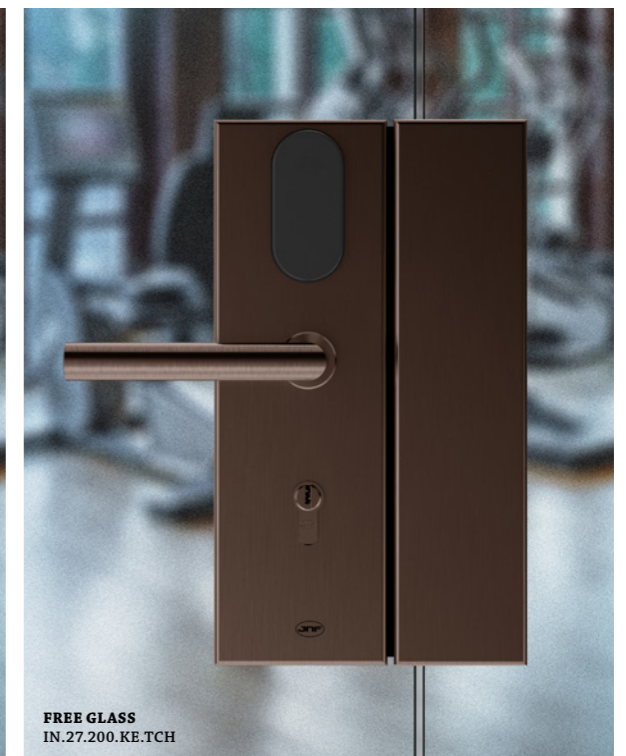

FREE GLASS
IN.27.200.KE.TCH

FREE GLASS
IN.27.200.KE



S90 > S-TRONIC

MODULAR ELECTRONIC CYLINDER

O cilindro electrónico S90 S-TRONIC é a solução ideal para uma mestragem que controla eletronicamente uma fechadura mecânica.

The S90 S-TRONIC cylinder is the ideal cost-effective solution for a master key system with electronically controlled locking and release.

El cilindro electrónico S90 S-TRONIC es una solución ideal para un mecanismo que controla electrónicamente una cerradura mecánica.

WWW.JNF.PT

JNF ARCHITECTURAL HARDWARE

POI Access Control Solutions

LUXURY HOTEL HARDWARE

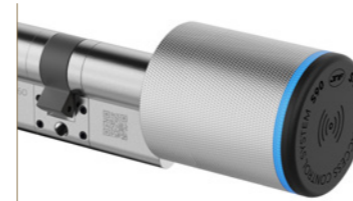

IN.19.S90... SATINADO / SATIN

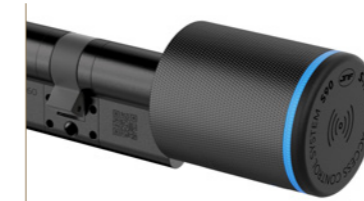

IN.19.S90...TB TITANIUM BLACK



IN.19.S90...TG TITANIUM GOLD

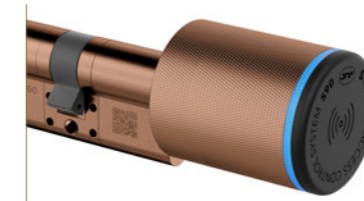

IN.19.S90...TCO TITANIUM COPPER



GATEWAY IN.27.522...

GATEWAY IN.27.523...



ADDITIONAL KEYPAD IN.27.530



GATEWAY IN.27.524...

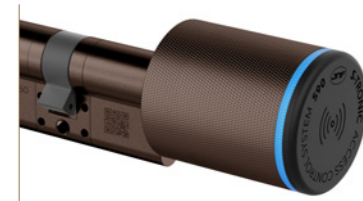

IN.19.S90...TCH TITANIUM CHOCOLATE

O cilindro electrónico S90 S-TRONIC é a solução ideal para uma mestragem que controla eletronicamente uma fechadura mecânica.

A construção modular de alta precisão permite uma variedade de tamanhos e simultaneamente uma resposta rápida a qualquer solicitação. O sistema é totalmente compatível com o programa VOYAGER JNF. Um cilindro electrónico sem manutenção, robusto e fácil de usar.

O sistema é usado intuitivamente aproximando o cartão do centro do botão, com a utilização de um smartphone ou de uma aplicação remotamente. O botão do lado exterior é engrenado quando um cartão com autorização é aproximado, permitindo abrir ou fechar a fechadura.

The S90 S-TRONIC cylinder is the ideal cost-effective solution for a master key system with electronically controlled locking and release.

A high-precision modular construction allows a wide range of sizes and simultaneously responds quickly to any request. The system is completely suitable with VOYAGER JNF program. A maintenance-free, robust and easy-to-use electronic cylinder.

The system is used intuitively by approaching the card to the center of the button, using a smartphone or an application remotely. The rotary thumb turn on the outside is engaged by using authorised identification media, thus enabling the lock to be locked or released.

El cilindro electrónico S90 S-TRONIC es la solución ideal para un maestramiento que controla electrónicamente una cerradura mecánica.

La construcción modular de alta precisión permite una variedad de tamaños y al mismo tiempo una respuesta rápida a cualquier solicitud. El sistema es totalmente compatible con todo el programa VOYAGER de JNF. Un cilindro electrónico sin mantenimiento, robusto y fácil de usar.

El sistema se utiliza de forma intuitiva acercando la tarjeta al centro del botón, utilizando un smartphone o una aplicación de forma remota. El botón en el exterior se activa cuando se acerca una tarjeta de autorización, lo que permite abrir o cerrar la cerradura.

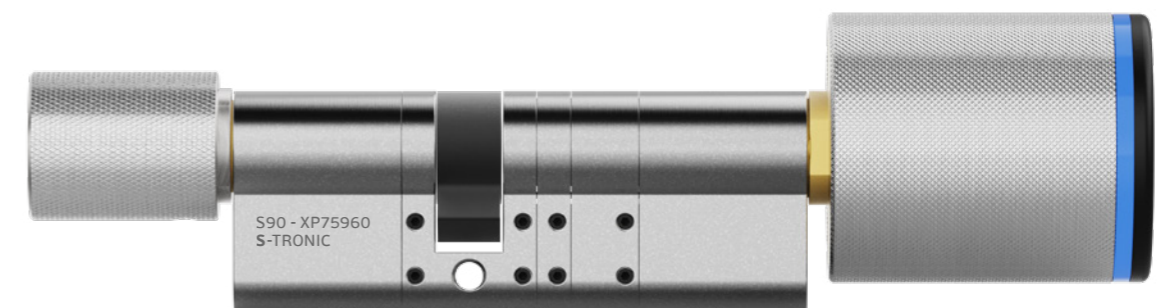

S-TRONIC
IN.19.S90 + IN.20.975.60.B + IN.27.153

MOBIL GUARD

ACCESS CONTROL
FOR CABINETS AND
LOCKERS.

MOBIL GUARD
Controlo de acessos
para armários
e cacifos.

MOBIL GUARD
Access control
for cabinets and
lockers.

MOBIL GUARD
Control de acceso
para armarios
y taquillas.



MOBIL GUARD
IN.28.120

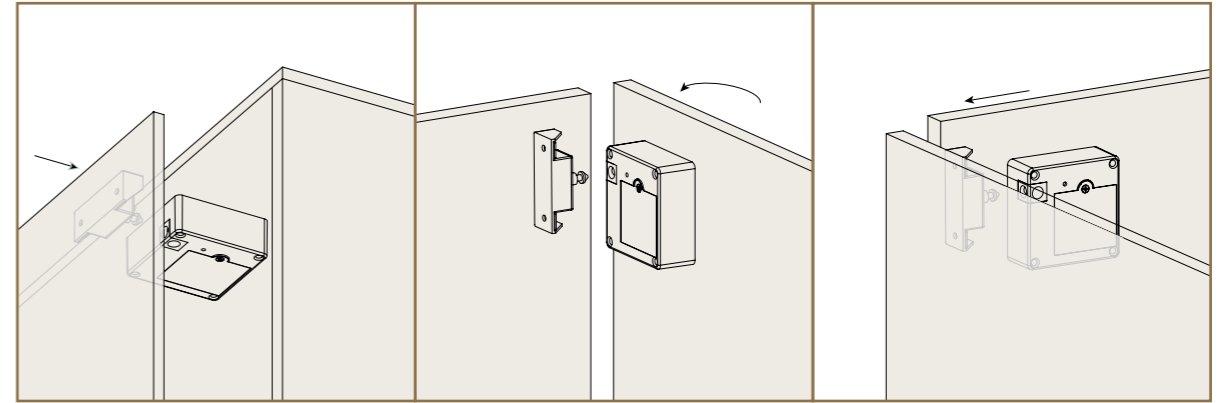

A solução perfeita para fazer o controlo de acessos de mobiliário, toda a eletrónica fica oculta no interior da porta, gaveta ou armário. Permite ser controlado remotamente ou em proximidade por tecnologia MIFARE.

The perfect solution for access control of furniture, all electronics are hidden inside the door, drawer or cabinet. Allows it to be controlled remotely or in proximity using MIFARE technology.

La solución perfecta para el control de acceso de muebles, toda la electrónica queda oculta dentro de la puerta, cajón o armario. Permite controlarlo de forma remota o en proximidad mediante tecnología MIFARE.



MOBIL GUARD KEYPAD.

Teclado numérico com dois modos de funcionamento Público / Privado. Botões analógicos e códigos encriptados.

Numeric keypad with two operating modes. (Public/Private) Analog buttons and encrypted codes.

Teclado numérico con dos modos de funcionamiento Público/Privado. Botones analógicos y códigos cifrados.

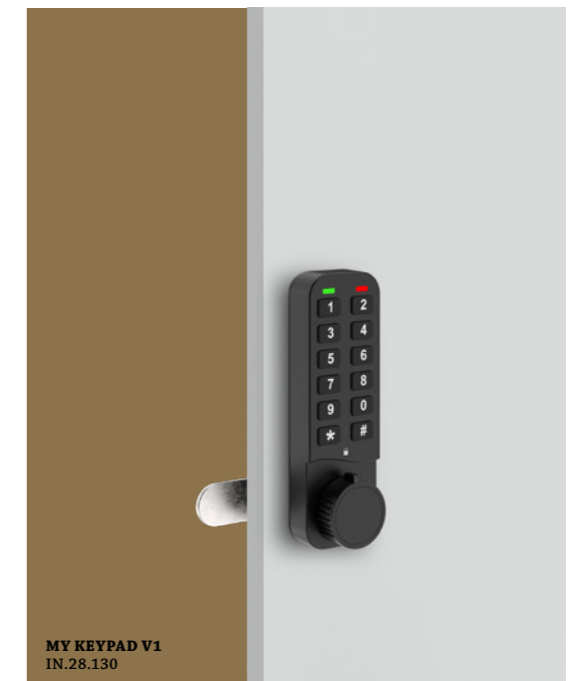

MY KEYPAD
IN.28.125

MY KEYPAD V1
IN.28.130

GATEWAY

VOYAGER GATEWAY

FULL LINKAGE CONNECTION

Permite transformar rapidamente os controlos de acesso Bluetooth em dispositivos online /

Allows to transform quickly the Bluetooth access controls into online devices /

Permite transformar rápidamente los controles de acceso Bluetooth en dispositivos online.

GATEWAY
IN.27.522.WIFI.W



The future is wireless.

Com o Sistema VOYAGER não é necessária a ligação por cabos para o controlo em tempo real dos dispositivos.

With the VOYAGER System is no longer required to wire network to have real time control on the devices

Con el Sistema VOYAGER No es necesario cablear para controlar en tiempo real los dispositivos.



GATEWAY
IN.27.522.WiFi.W
IN.27.522.LAN.W



GATEWAY
IN.27.523.WiFi.W
IN.27.523.LAN.W



GATEWAY
IN.27.524.WiFi.W



GATEWAY
IN.27.422



GATEWAY
IN.27.522.WiFi.B
IN.27.522.LAN.B



GATEWAY
IN.27.523.WiFi.B
IN.27.523.LAN.B



GATEWAY
IN.27.524.WiFi.B

O gateway VOYAGER permite transformar rapidamente os controlos de acesso Bluetooth em dispositivos online, aumentando a gestão e controlo dos dispositivos, acessível em qualquer parte do mundo.

A distância e presença deixam de ser um problema, mesmo quando é necessário fazer a gestão de vários locais com o sistema VOYAGER. O acesso é feito remotamente usando ligações Bluetooth, wi-fi, CLOUD e o telemóvel do proprietário.

A segurança na CLOUD é garantida pelo alojamento da informação num servidor na Europa, certificado.

Configuração Plug & Play através do telemóvel com aplicação JNF wifi, disponível na Apple Store ou Play Store.

The VOYAGER gateway lets you quickly transform Bluetooth access controls into online devices, increasing device management and control, accessible anywhere in the world.

Distance and presence are no longer a problem, even when it is necessary to manage multiple locations with the VOYAGER system. Access is done remotely using Bluetooth, wi-fi, CLOUD and the owner's mobile phone.

Cloud security is guaranteed by hosting information on a certified server in Europe.

Plug & Play configuration via mobile phone with JNF wifi app, available in Apple Store or Play Store.

El gateway VOYAGER permite transformar rápidamente los controles de acceso Bluetooth en dispositivos online, aumentando la gestión y el control de dispositivos, accesibles en cualquier parte del mundo.

La distancia y la presencia ya no son un problema, incluso cuando es necesario gestionar múltiples ubicaciones con el sistema VOYAGER. El acceso se realiza de forma remota mediante Bluetooth, wi-fi, CLOUD y el teléfono móvil del propietario.

La seguridad en la CLOUD está garantizada mediante el alojamiento de información en un servidor certificado en Europa.

Configuración Plug & Play es hecha a través del teléfono móvil con la aplicación wifi JNF, disponible en Apple Store o Play Store.

HOTEL NETWORK

ACCESS CONTROL SYSTEM AND MANAGEMENT FOR HOTELS.

Rede intranet dedicada para Sistema de controle de acesso e gestão hoteleira.

Intranet network dedicated for Access control system and management for hotels.

Red intranet dedicada para el sistema de control Accesos y gestión hotelera.



IN.27.558
Leitor de cartões.
Permite ler o ID do cartão e comunica com o software VOYAGER

Card reader.
Allows reading the ID card and communicates with the VOYAGER software

Lector de tarjetas.
Permite leer el ID de tarjeta y se comunica con el software VOYAGER.

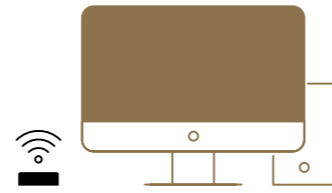

IN.27.580
JNF - Smartbox
Server with Software
VOYAGER Corporate



IN.27.582
JNF - Wireless Access Point
with Endpoint Protection



IN.27.583
JNF - Switch Firewall



IN.27.581
JNF - Router Firewall
WiFi & Lan PoE



A solução de rede intranet, dedicada exclusivamente ao sistema de controle de acesso e à gestão do seu hotel.

Para garantirmos uma rede segura, temos uma solução de rede fechada Intranet, autónoma e dedicada ao controlo de acessos e à gestão hoteleira com o Software VOYAGER CORPORATE.

The intranet network solution, dedicated exclusively to access control system and your hotel management.

To guarantee a secure network, we have a closed Intranet network solution, autonomous and dedicated to access control and hotel management with the VOYAGER CORPORATE. software.

La solución de red intranet, dedicada exclusivamente al sistema de control de acceso y gestión de su hotel.

Para garantizar una red segura, disponemos de una solución de red Intranet cerrada, autónoma y dedicada al control de acceso y gestión hotelera con el software VOYAGER Corporate.

Solution 1 LAN connections

VOYAGER CORPORATE

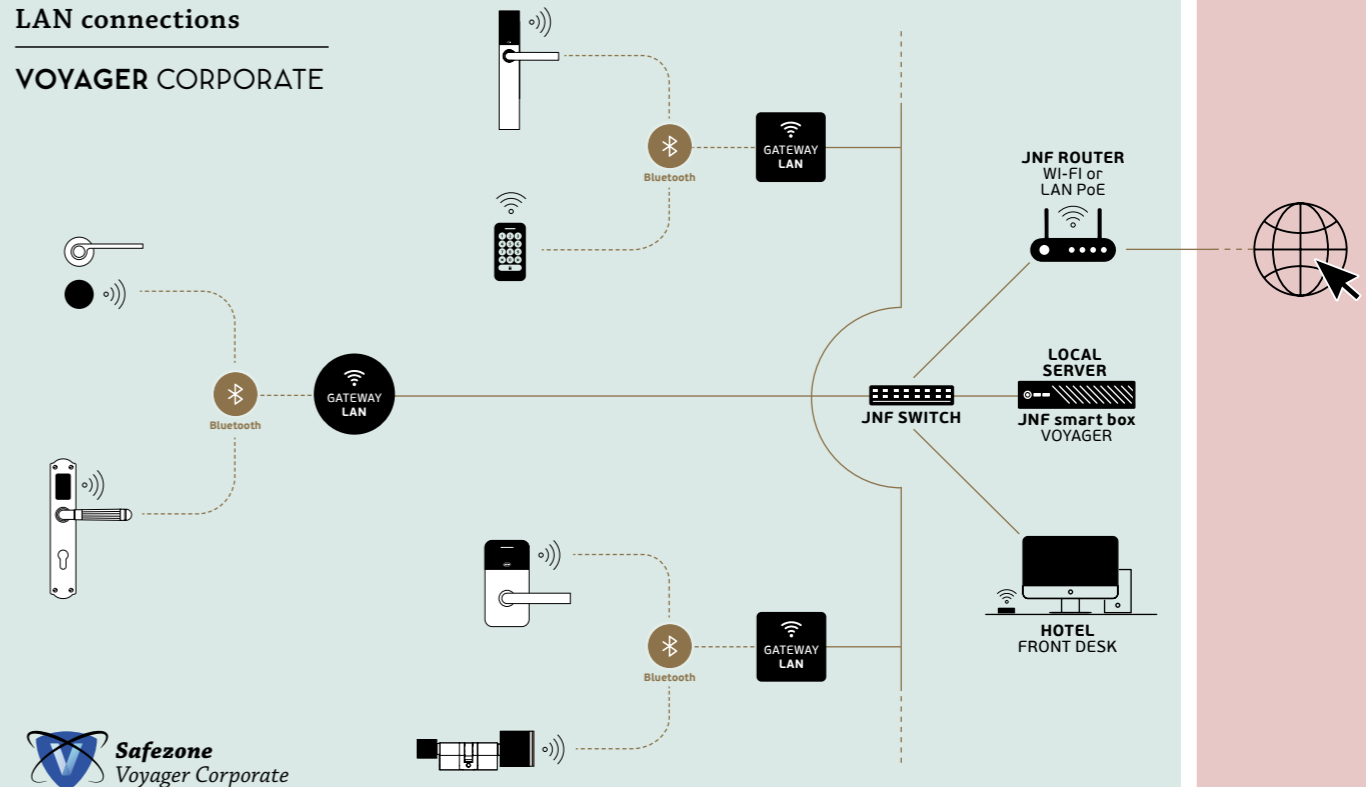

Solution 2 WiFi connections

VOYAGER CORPORATE

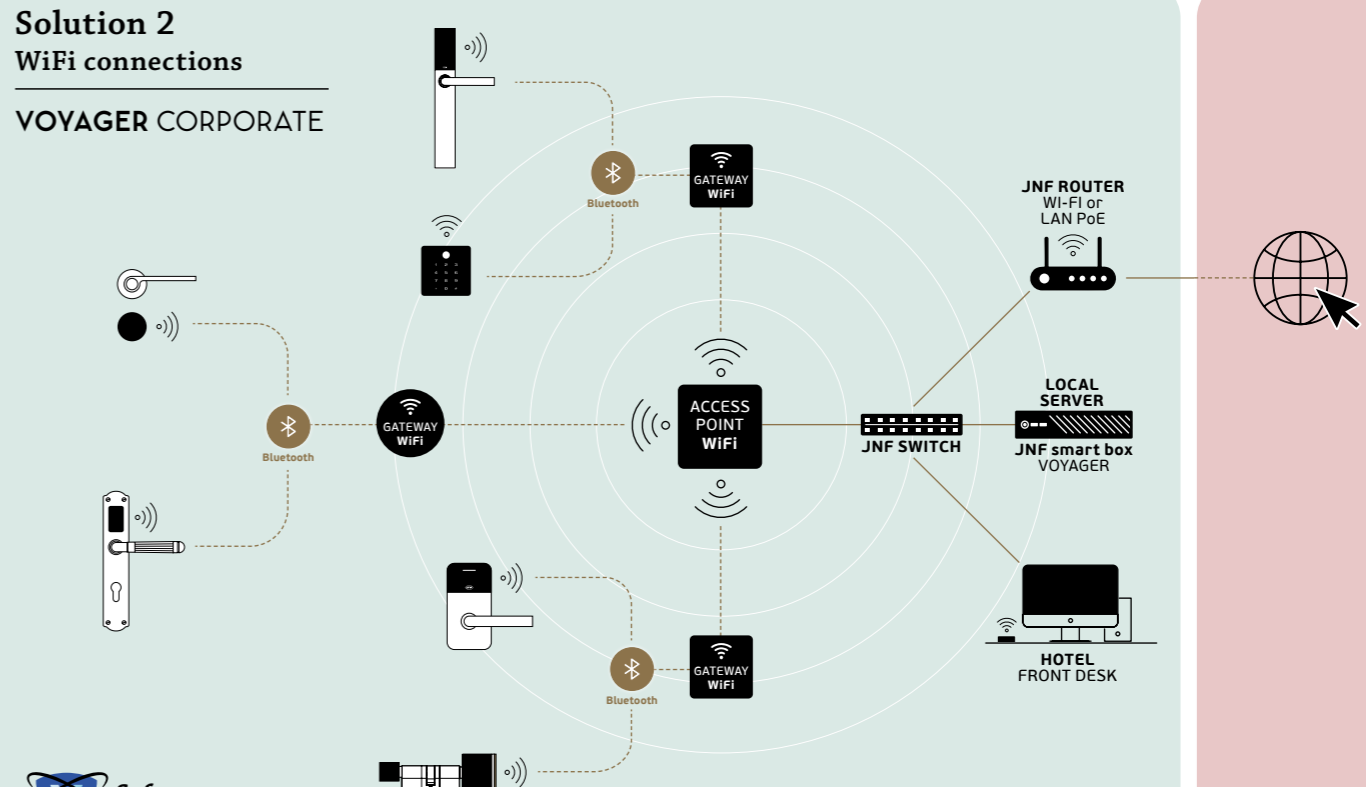

SAFE BOX DECOR

ELECTRONIC SAFE BOX FOR HOTEL.

Cofre digital eletrónico com teclado numérico analógico iluminado. Diferentes acabamentos disponíveis em PVD TITANIUM com cores preto, dourado, cobre e chocolate.

Electronic digital safe box with illuminated analog numeric keypad. Different finishes available in PVD TITANIUM with black, gold, copper and chocolate colors.

Caja fuerte digital electrónica con teclado numérico analógico iluminado. Diferentes acabados disponibles en PVD TITANIO con colores negro, oro, cobre y chocolate.



IN.28.904
BLACK



IN.28.904.IN
Satinado / Satin



IN.28.904.TB
PVD Titanium Black



IN.28.904.TG
PVD Titanium Gold



IN.28.904.TCO
PVD Titanium Copper



IN.28.904.TCH
PVD Titanium Chocolate

SAFE BOX DECOR
Size: 420x370x200 mm



LED DISPLAY



4-6 DIGITS



LIGHT INSIDE



NUMBER KEYPAD



HIGH SECURITY



4 BATTERY AA



MASTER SECURITY KEY



MASTER SECURITY CODE



TYPE - C



LAPTOP 15"





TOREL AVANTGARDE
(Porto, Portugal)

NN Arquitectura

TOREL PALACE
(Porto, Portugal)

NN Arquitectura



SOLUÇÕES PARA PORTAS

Resolvemos quase todas as necessidades, seguindo as exigências necessárias neste âmbito, como as certificações, design e características técnicas.

Podemos fornecer puxadores, asas de porta, fechaduras, dobradiças, pivots, molas de porta, batentes de portas, visores de portas, retenedores de portas, tudo isto combinado com uma enorme quantidade de acessórios que garantem que todo o conjunto funciona.

DOOR SOLUTIONS

We are able to solve almost all needs, following the demands for this situation, as for the certifications, design and technical features.

We can provide handles, pull handles, locks, hinges, pivots, door closers, door stoppers, door viewers, door catchers, all of this combined with a huge quantity of accessories that will make it work together.

SOLUCIONES PARA PUERTAS

Resolvemos casi todas las necesidades, siguiendo las exigencias necesarias en este ámbito, como las certificaciones, el diseño y las características técnicas.

Podemos suministrar manillas, manillones de puerta, cerraduras, bisagras, pivotes, muelles de puerta, tope de puertas, visores de puertas, retenedores de puertas, todo ello combinado con una enorme cantidad de accesorios que garantizan que todo en conjunto funciona.

1. IN.07.204.D.35
2. IN.05.061
3. IN.05.021.75.CF
4. IN.23.010.B
5. IN.00.116
6. IN.13.122
7. IN.00.310
8. IN.13.111.50

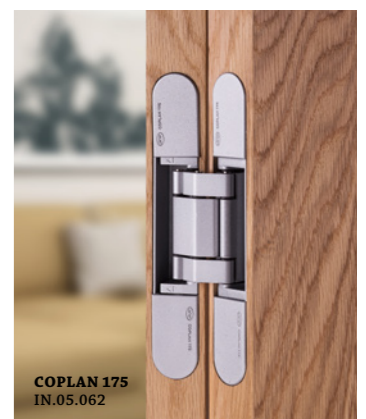
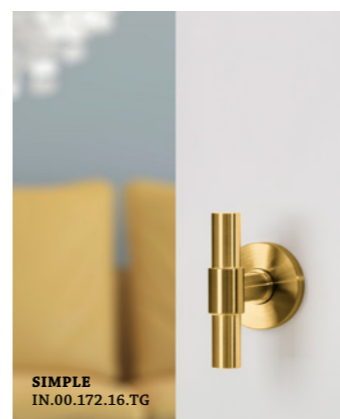
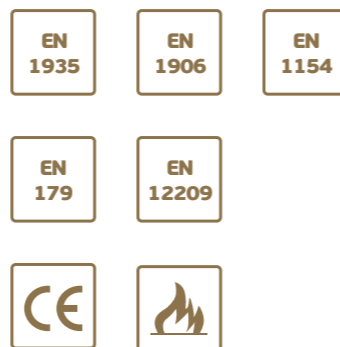
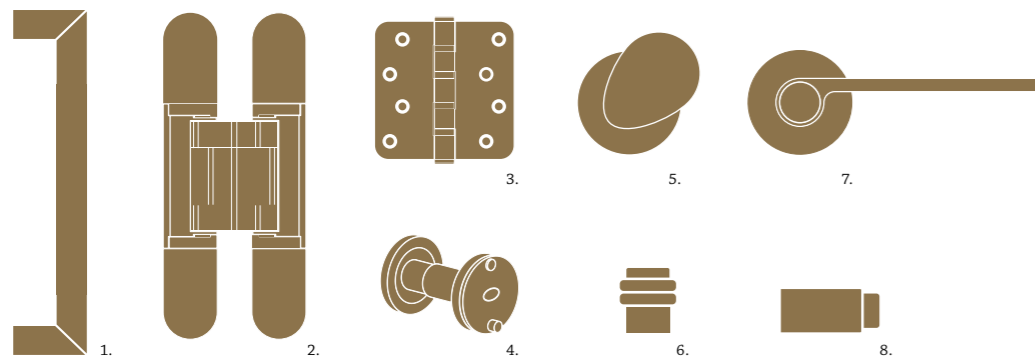



SOLUÇÕES PARA PORTAS

DE CORRER & LIVRO

Em primeiro lugar, são desenvolvidos para economizar espaço, tornando-se populares em muitos espaços contemporâneos devido à sua impressionante capacidade de abertura total e poder juntar duas áreas diferentes. Os nossos sistemas de portas de correr e de livro são ideais para espaços grandes e portas de parede a parede, obtendo-se uma passagem ampla. Estes desenhos preservam o espaço interno, mesmo quando as portas estão totalmente abertas. Temos soluções para portas de correr automáticas e manuais, adequadas para todas as áreas, inclusivamente em zonas exteriores.

SLIDING & FOLDING DOOR SOLUTIONS

First off all they are space-saving designs, they become popular addition to many contemporary spaces because of their impressive capacity to open up an interior, and unite two different areas. Our sliding and folding doors systems are ideal for larger spaces or wall to wall doors getting a wide doorway. This shrewd design preserves the internal space, even when the doors are fully open. We have solutions for automatic and manual sliding doors, suitable for all areas even outside use.

SOLUCIONES PARA PUERTAS CORREDERAS Y PLEGABLES

En primer lugar, se desarrollan para ahorrar espacio, haciéndose populares en muchos espacios contemporâneos debido a su impresionante capacidad de apertura total y poder unir dos áreas distintas. Nuestros sistemas de puertas correderas y plegables son ideales para espacios grandes o puertas de pared a pared, obteniéndose una pasaje amplia. Estos diseños preservan el espacio interior, incluso cuando las puertas están totalmente abiertas. Tenemos soluciones para puertas correderas automáticas y manuales, adecuadas para todas las áreas, incluso en zonas exteriores.

1. IN.15.002
2. IN.15.302
3. IN.15.301
4. IN.15.123.5
5. IN.15.038
6. IN.15.039

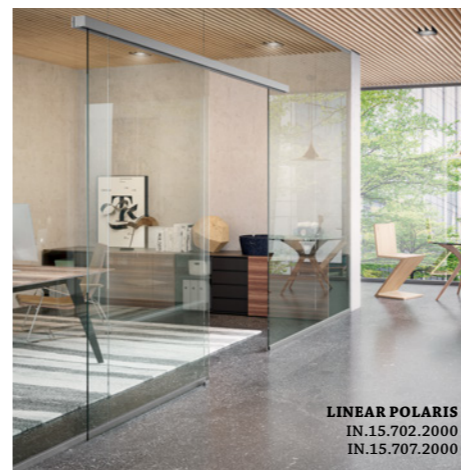
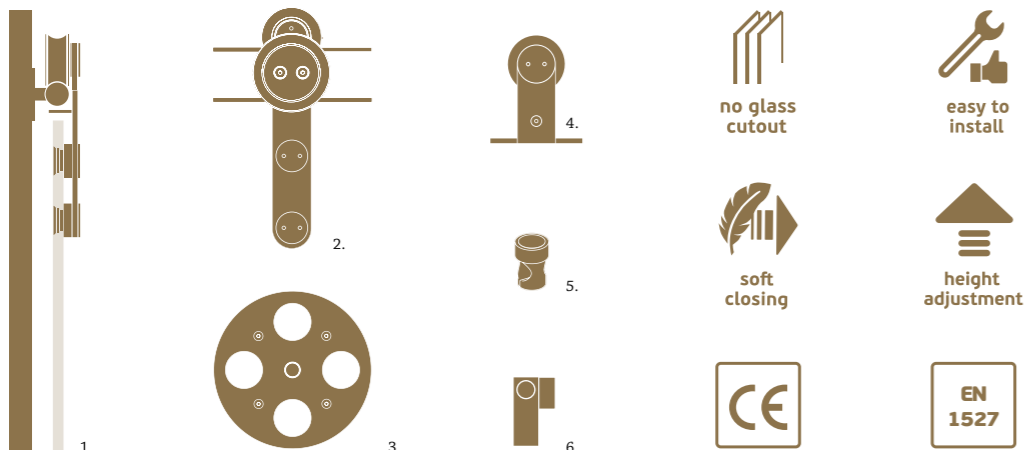

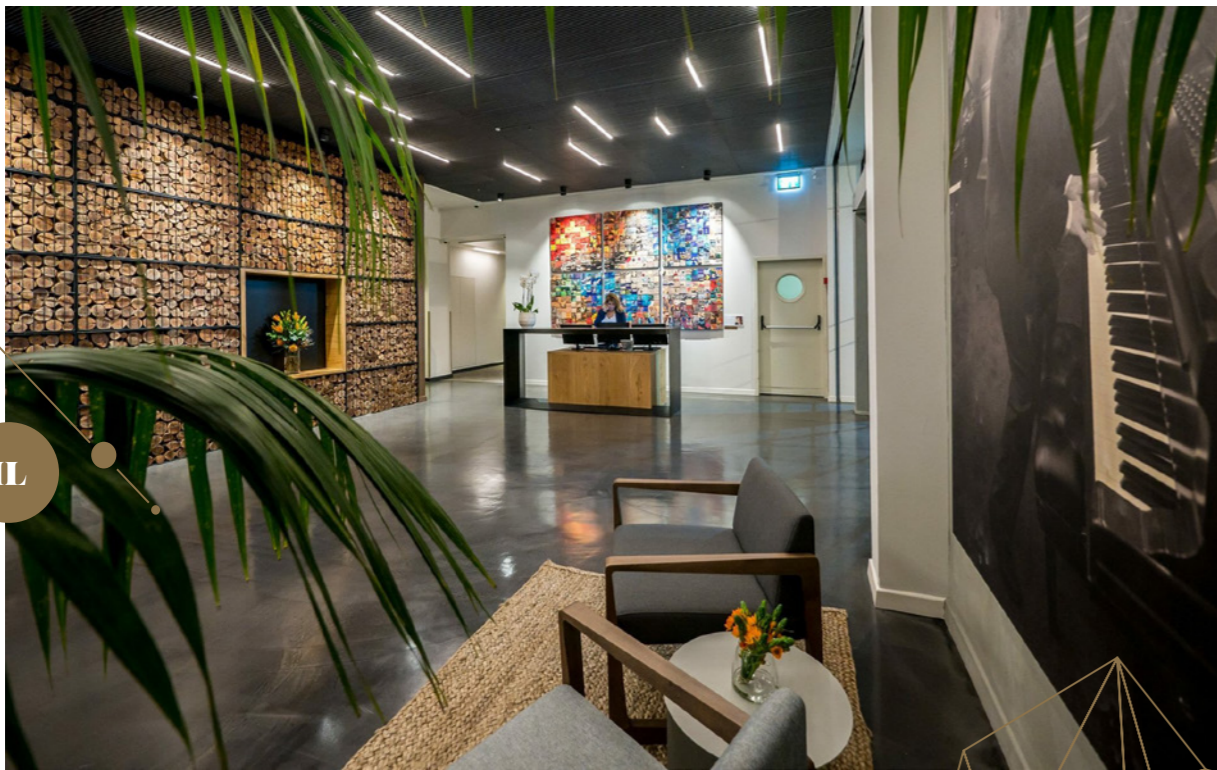

IL



PT

JOÃO MORGADO ©



HOTEL LA CAPELLA (Israel)



JOÃO MORGADO ©

HOTEL TORRE DA GOMARIZ (Portugal)

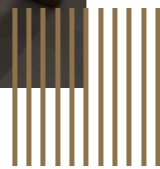
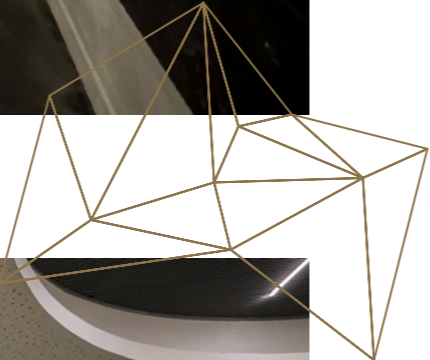



H2 SYSTEM

SOLUÇÕES PARA VIDRO

Todas as peças e sistemas são desenvolvidos de acordo com os requisitos mais exigentes da indústria do vidro, criando uma fusão entre as características técnicas e estéticas.

GLASS SOLUTIONS

All parts and systems are developed according with the most demanding requirements of the glass industry, in the context of functionality and aesthetic fusion.

SOLUCIONES PARA CRISTAL

Todas las piezas y sistemas se han desarrollado según los requisitos más exigentes de la industria del cristal, creando una fusión entre las características técnicas y estéticas.

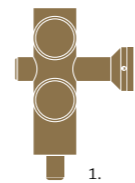

1.

- 1. IN.81.253
- 2. IN.81.250
- 3. IN.81.254
- 4. IN.80.460
- 5. IN.81.255
- 6. IN.81.256



2.



3.



4.

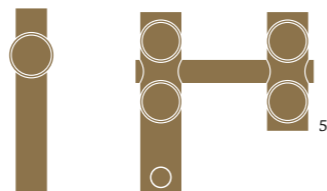

5.



6.



ML.21.765 + 21.101. AN
21.BMV.765



IN.20.952.K2



W SYSTEM
IN.05.322.TG
IN.07.432.TG



IN.00.172.16.V.KN.TB



IN.81.502

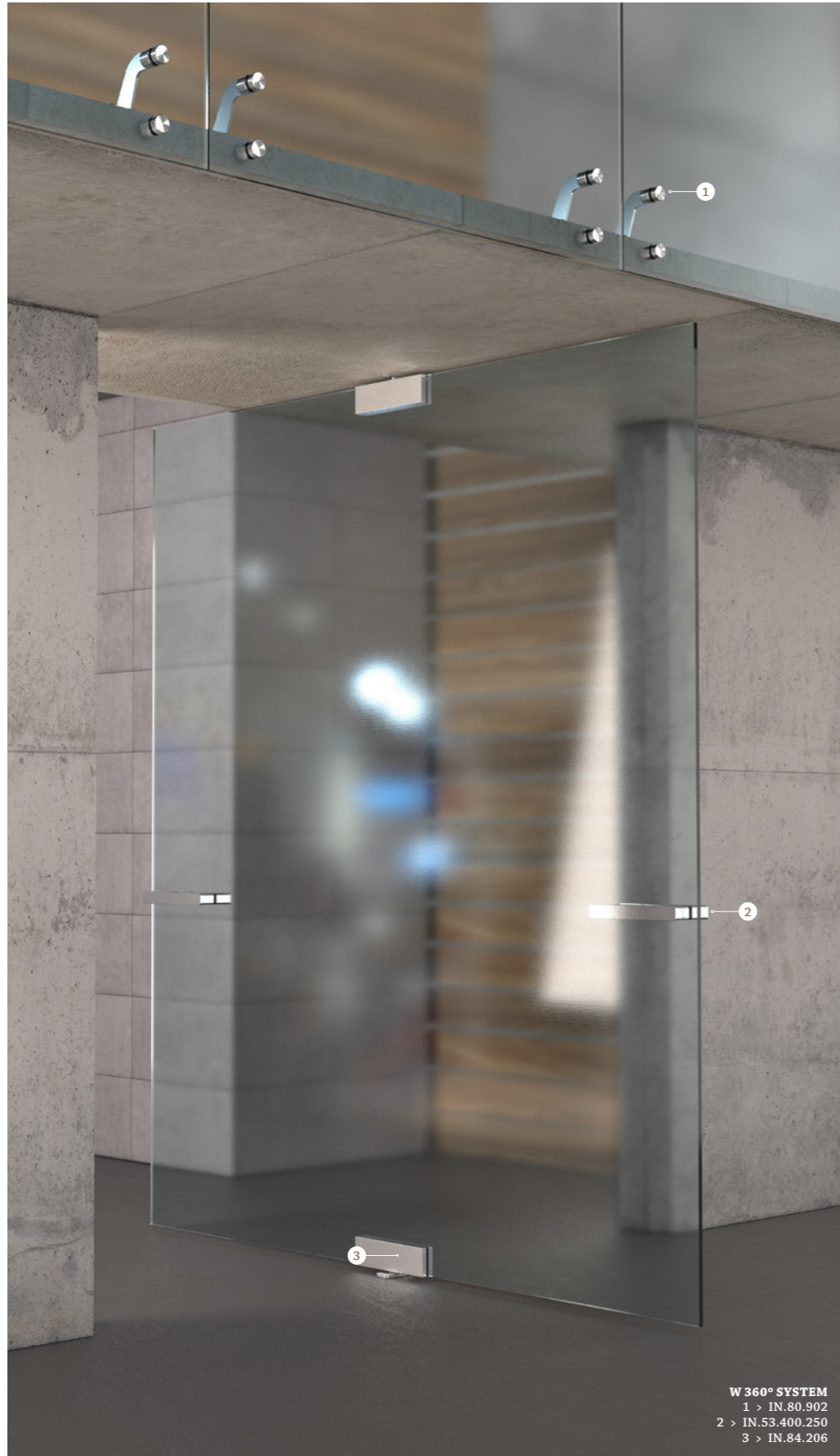

W 360° SYSTEM
 1 > IN.80.902
 2 > IN.53.400.250
 3 > IN.84.206

**W 360°
 HYDRAULIC
 PATCH FITTING
 FOR GLASS**

Conjunto completo de pivot hidráulico para portas de vidro.
 Sistema pivotante para portas de vidro de grandes dimensões. O sistema CAM integrado neste pivot permite que a porta possa fazer uma rotação de 360°, mantendo o sistema hidráulico com fecho automático e suave. Para funcionar desta forma o pivot superior e inferior terão de estar instalados ao centro da porta. /

Hydraulic pivot set for glass doors.
 Pivoting system for large glass doors. The CAM system integrated in this pivot allows the door to rotate 360°, maintaining the hydraulic system with automatic and soft closing. To function in this way the upper and lower pivot must be installed in the centre of the door. /

Juego completo de pivote hidráulico para puertas de cristal.
 Sistema pivotante para puertas de cristal de grandes dimensiones. El sistema CAM integrado en este pivote permite que la puerta gire 360°, manteniendo el sistema hidráulico con cierre automático y suave. Para funcionar de este modo, el pivote superior e inferior deben instalarse en el centro de la puerta. /

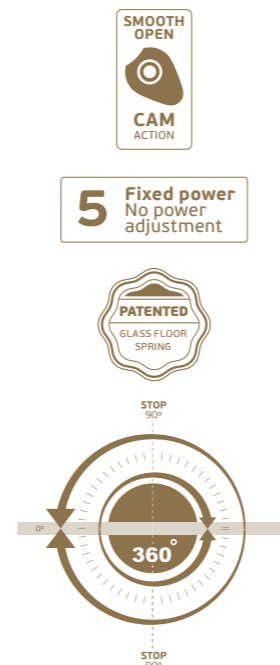

1 > IN.27.002
 2 > IN.27.005
 3 > IN.07.201.1200
 4 > IN.27.00.D
 5 > IN.27.001

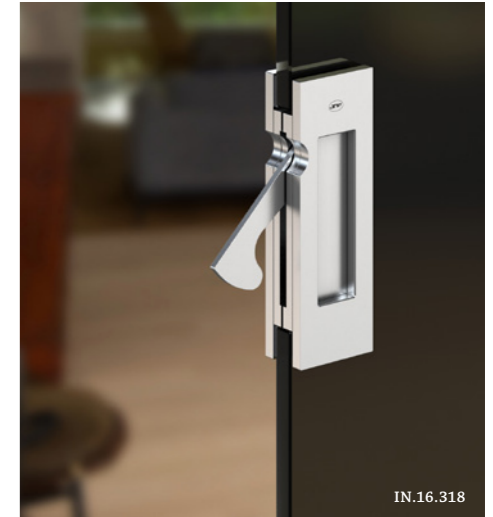

IN.16.318



IN.05.321 + IN.05.313



IN.16.322

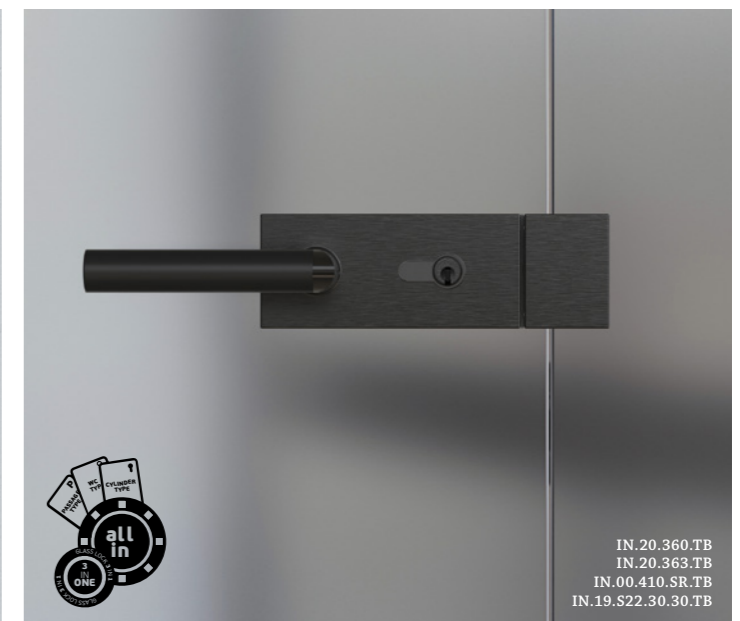

IN.20.360.TB
 IN.20.363.TB
 IN.00.410.SR.TB
 IN.19.S22.30.30.TB



PLANAR FLUSH HANDLES
IN.16.020.200.TG
IN.16.020.200.PZ.TG

SOLUÇÕES PARA ARMÁRIOS
JNF pode fornecer ferragens desde os puxadores às cruzetas, usando aço inoxidável como material base e opcionalmente acabamentos PVD com diferentes cores para combinar com a decoração do quarto. Também podemos misturar diferentes materiais, como o couro, criando um toque mais quente e confortável.

CLOSET SOLUTIONS
JNF can provide hardware from the handles to the cloth hangers, using stainless steel as main material and optionally PVD color finishes to match room decoration. Also, we can mix different materials like leather, creating a warmer and comfortable touch.

SOLUCIONES PARA ARMARIOS JNF puede suministrar herrajes desde los tiradores a las perchas, usando acero inoxidable como material base y opcionalmente acabados PVD con distintos colores para combinar la decoración de la habitación. También podemos mezclar distintos materiales, como el cuero, creando un toque más cálido y cómodo.

- | | | |
|-----------------|-----------------|---------------|
| 1. IN.16.317.R | 6. IN.22.004 | 11. IN.22.132 |
| 2. IN.22.107 | 7. IN.16.225.50 | 12. IN.22.133 |
| 3. MV.22.010 | 8. IN.14.012 | 13. IN.22.131 |
| 4. IN.22.152.14 | 9. IN.22.280 | 14. IN.22.130 |
| 5. IN.22.125.18 | 10. IN.14.506.3 | |

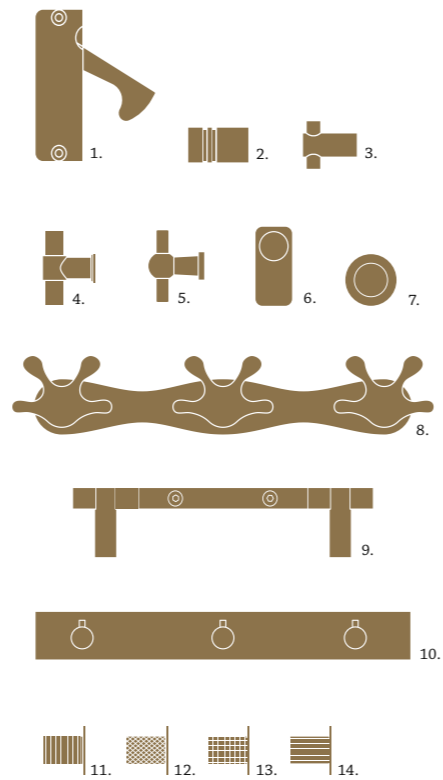

IN.22.500.1250



IN.16.241.TCO



RETRACTABLE HANDLE
IN.16.317



CONNECT SYSTEM
IN.14.040.C
IN.14.041.C



WATCH
IN.22.162.KN.TCO



SOLUÇÕES DE DUCHE
SHOWER SOLUTIONS
SOLUCIONES DE DUCHA

1. IN.15.002
2. IN.15.210
3. IN.15.601
4. IN.15.602
5. IN.15.352

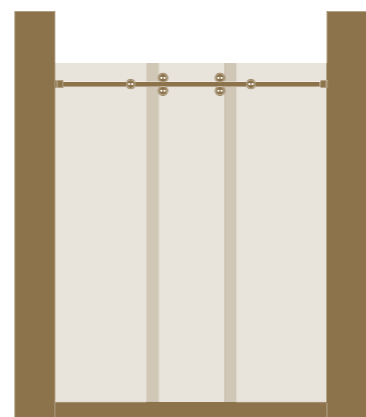
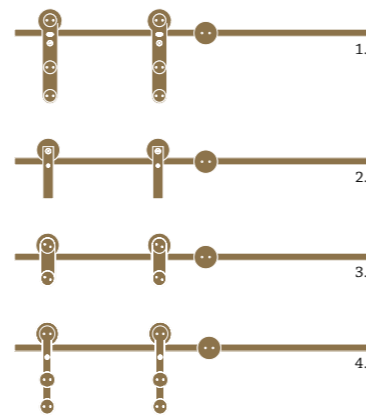



SLIM SHOWER SYSTEM
IN.15.360



SLIM SHOWER SYSTEM
IN.15.364.B

SLIM SHOWER SYSTEM

Sistema modular adaptável a qualquer configuração de chuveiro. Kit completo com exceção do vidro.
O configurador facilita a configuração da cabine e todas as medidas necessárias para a produção dos vidros. /

Modular system adaptable to any shower configuration. Complete SEt except the glass. The configurator makes it easy to create the cabin and all the necessary measures for the glass production. /

Sistema modular adaptable a cualquier configuración de cabinas. Kit completo excepto el vidrio. El configurador facilita la configuración de la cabina y todas las medidas necesarias para la producción de los vidrios.

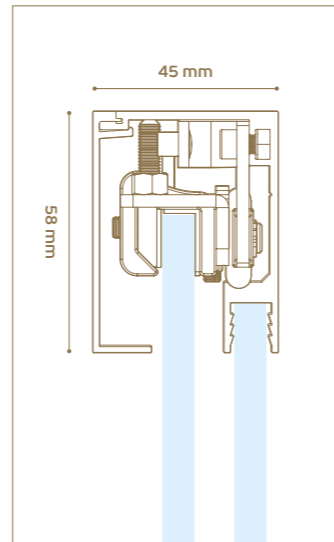

soft closing

- HEIGHT ADJUSTMENT
- SILENT MOVEMENT
- KIT
- 8 mm
- NO glass cut
- 40 kg
- Max: 2000 mm
- DDA
-



1 > IN.80.600.900.TB
2 > IN.05.315.TB
3 > IN.07.432.TB
4 > IN.14.204.B



BRANCH
IN.52.304.425
IN.08.BRC.35

SOLUÇÕES PARA CASA DE BANHO
A JNF desenvolve séries completas para casa de banho, adaptadas de forma a combinar com cada tipo de decoração criando um ambiente mais confortável e harmonioso. Ao longo dos anos, a equipa de design JNF juntamente com outros designers e arquitectos desenvolveram várias colecções.

BATHROOM SOLUTIONS
By developing complete bathroom series, JNF is able to adapt with each and every type of decoration creating a comfortable and harmonious surrounding. Throughout the years, JNF design team along with other external designers and architects have created several bathroom collections.

SOLUCIONES DE BAÑO
JNF desarrolla series completas para baños, adaptadas para combinar con cada tipo de decoración creando un ambiente más cómodo y armonioso. A lo largo de los años, el equipo de diseño JNF junto con otros diseñadores y arquitectos han desarrollado varias colecciones.

- | | |
|--------------|-------------------|
| 1. IN.52.300 | 6. IN.52.308 |
| 2. IN.52.301 | 7. IN.14.300.14.3 |
| 3. IN.52.304 | 8. IN.52.302 |
| 4. IN.52.303 | 9. IN.65.201.12 |
| 5. IN.52.305 | 10. IN.65.203.12 |

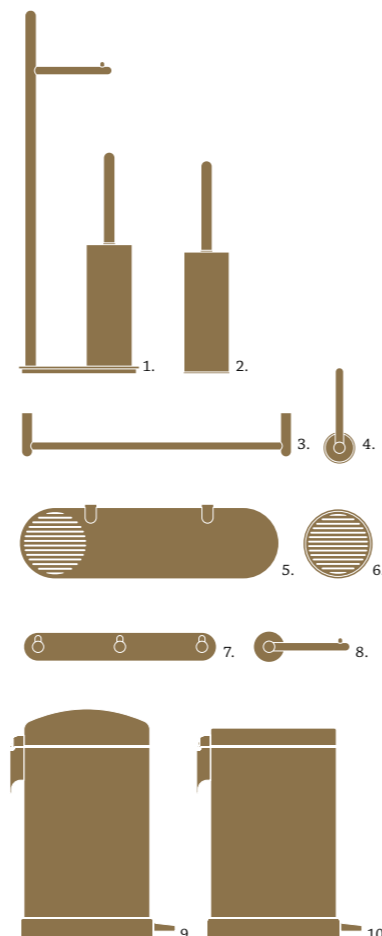

BRANCH
IN.52.308



BRANCH
IN.52.304.425
IN.52.308



NATUR
IN.53.200.425.TG
IN.14.125.TG
IN.14.124.TG
IN.53.202.TG
IN.53.201.TG
IN.42.164.TG

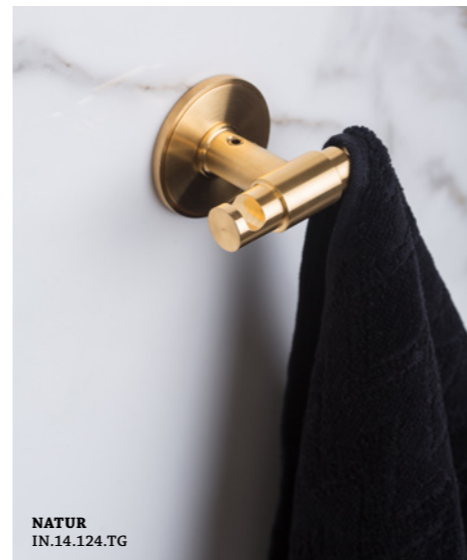

NATUR
IN.14.124.TG



NATUR
IN.53.202.TG



WOOD NATURE
IN.53.381...C
IN.14.381.C
IN.53.382.C
IN.53.383.C

WOOD NATURE

A JNF alia a sustentabilidade dos materiais à natureza, numa nova linha, a Wood Nature. A coleção Bétula tem como matéria-prima essa madeira, que se encontra certificada pelo FSC®, sendo extremamente sustentável, de crescimento rápido e flexível. O desenho das peças desta coleção assemelha-se a galhos e troncos de bétulas luminosas, que invariavelmente são utilizadas nas peças de carpintaria escandinavas, onde prevalece a simplicidade, a linha reta e a cor neutra.

JNF combines the sustainability of materials with nature, in a new line, Wood Nature. birch wood, FSC® certified, extremely sustainable, fast growing and flexible. The design of the pieces in this collection resembles the branches and trunks of luminous birch trees, which are invariably used in Scandinavian carpentry, where simplicity, straight lines and neutral colors prevail.

JNF combina la sostenibilidad de los materiales con la naturaleza, en una nueva línea, Wood Nature. madera de abedul, certificada FSC®, extremadamente sostenible, de rápido crecimiento y flexible. El diseño de las piezas de esta colección se parece a las ramas y troncos de los luminosos abedules, que se utilizan invariablemente en la carpintería escandinava, donde prima la sencillez, las líneas rectas y los colores neutros.



WOOD NATURE
IN.14.381.BE



WOOD NATURE
IN.53.381...BE

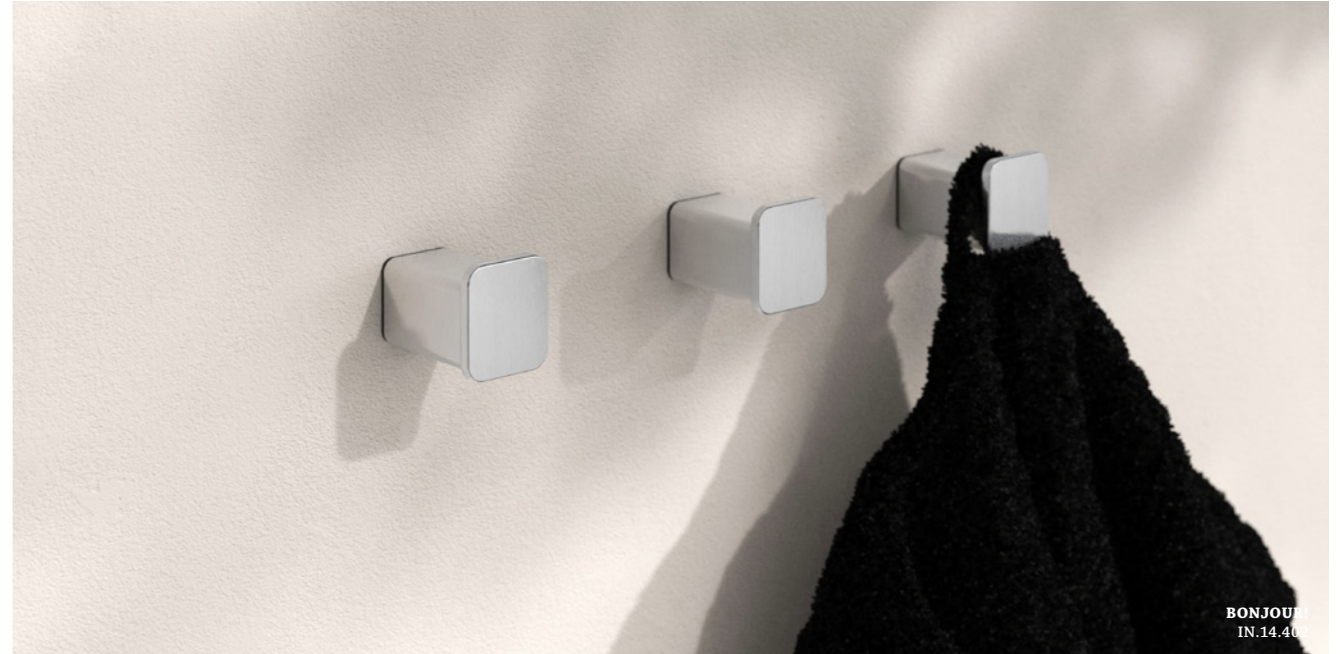

BONJOUR
IN.14.40



SLIM BLACK
IN.44.206

SLIM WHITE
IN.44.201.425.W

WHITE SERIES
IN.14.502



IN.60.491.B +
IN.60.491.W +
IN.60.490.BF3



STEEL GLASS
IN.53.501.TG



IN.60.490.L



IN.41.141.19.425.TVK

ES



NEYA Hotel
(Porto, Portugal)

PK Arquitetos Lda + Colectivo ODD

PT



RESIDÊNCIA UNIVERSITÁRIA DE GANDRA
(Gandra, Portugal)



SOLUÇÕES DE BANHOS PÚBLICOS
 A JNF oferece uma extensa gama de produtos para melhorar e organizar as casas de banhos de âmbito público, de acordo com as legislações em vigor. A nossa ampla gama e produtos adequa-se a todos os tipos de negócios (pequenos ou grandes), com instalações abertas ou fechadas para o público.

WASHROOM SOLUTIONS
 JNF offers an extensive range of products to enhance the washroom, whilst ensuring organisation complies with important legislation. Our wide range of washroom products are suitable for all types of business, large or small, with premises open or closed to the public.

SOLUCIONES PARA BAÑOS PÚBLICOS
 JNF ofrece una amplia gama de productos para mejorar y organizar las aseos de ámbito público, de acuerdo con las legislaciones en vigor. Nuestra amplia gama y productos se adaptan a todo tipo de negocios (pequeños o grandes), con instalaciones abiertas o cerradas para al público.

- 1. IN.60.565
- 2. IN.60.561
- 3. IN.60.564
- 4. IN.60.563
- 5. IN.60.565

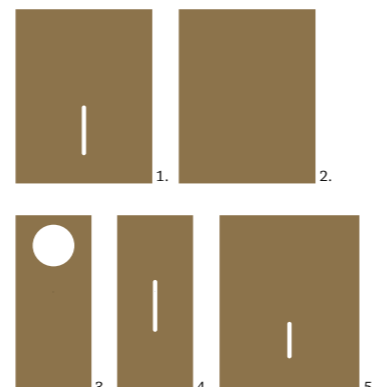

IN.60.562 + IN.60.548



IN.60.566



IN.60.566.TB
 IN.60.563.TB
 IN.60.548.TB
 IN.60.561.TB



IN.60.548.TG +
 IN.60.561.TG +
 IN.60.562.TG

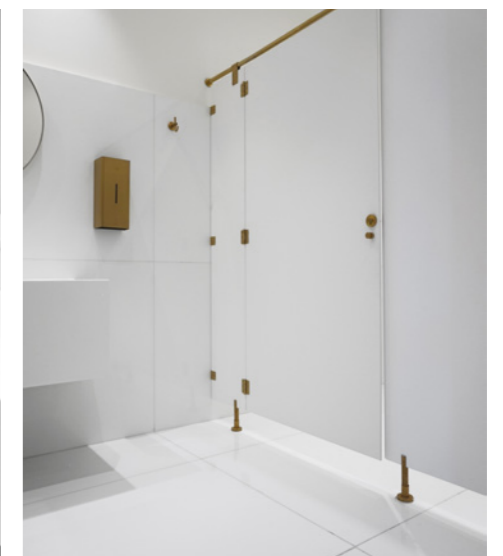





JOSÉ CAMPOS ©

OHPORTO
(Porto, Portugal)



JOSÉ CAMPOS ©



JOSÉ CAMPOS ©

OHPORTO
(Porto, Portugal)



IN.26.941 + IN.26.939.D

SOLUÇÕES PARA SINALÉTICA

A comunicação visual é fundamental na área de hospitalidade. O desenvolvimento de sinalética (imagens / letras / algarismos), é realizado de forma a facilitar a sua leitura pelo público geral. Criamos sinalética personalizada, a pedido especial.

SIGNAGE SOLUTIONS

Visual communication is key in the hospitality area. By designing and creating a vast number of icons (images / letters / numbers) everyone can easily understand their surroundings. By special request, we can also create custom made signage.

SOLUCIONES DE SEÑALIZACIÓN

La comunicación visual es fundamental en el área de hospitalidad. El desarrollo de señalización (imágenes / letras / números), se realiza de forma que facilite su lectura por el público en general. Creamos una señalización personalizada, a petición especial.

Showroom

R O O M
1 0 1

4 2 0



IN.60.574
IN.26.939.D + IN.26.941



IN.34.000.P.2
IN.34.000.P.1



IN.26.401.S



IN.20.951 + IN.20.953

SISTEMAS DE FECHO & SEGURANÇA

Uma das áreas mais importantes Num projeto de hospitalidade é a SEGURANÇA. É um assunto que deve ser encarado de forma mais cuidada e atenta. Todos os padrões e certificações são rigorosamente seguidos pelos nossos engenheiros e departamentos de controlo de qualidade.

EXIT & SECURITY SOLUTIONS

One of the most important areas in an hospitality project is SECURITY. When it comes to the security of people we must treat this subject very carefully, All standards and certifications are strictly followed by our engineers and quality control departments.

SISTEMAS DE CIERRE & SEGURIDAD

Una de las áreas más importantes en un proyecto de hospitalidad es la SEGURIDAD. Es un asunto que debe ser encarado de forma más cuidadosa y atenta. Todos los estándares y certificaciones son estrictamente seguidos por nuestros ingenieros y departamentos de control de calidad.

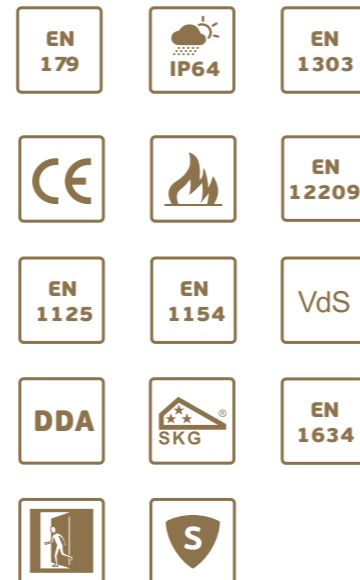

ML.21.770 + 21.770.HD + IN.21.BD + IN.05.020.M



IN.21.900.B



IN.28.108.B



IN.28.065

ACABAMENTOS MECÂNICOS EM AÇO INOXIDÁVEL

MECHANICAL FINISHES IN STAINLESS STEEL
ACABADOS MECÂNICOS EN ACERO INOXIDABLE

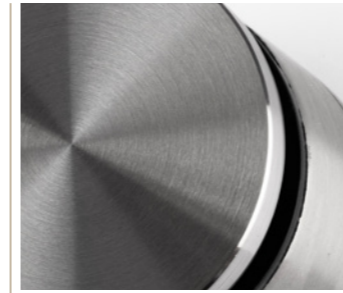

AÇO INOXIDÁVEL SATINADO OU ESCOVADO /
SATIN OR BRUSHED
STAINLESS STEEL /
ACERO INOX SATINADO O
CEPILLADO.

SATINADO
É O NOSSO ACABAMENTO PADRÃO
O aço é polido de forma a conseguir
um acabamento "mate" sem brilho.
O nosso acabamento mate é obtido
com materiais de alta qualidade,
consequindo-se superfícies de muito
baixa rugosidade mas que, no entanto,
continuam sem brilho, funcionando
como peças "neutras" reflectindo de
forma ténue os tons envolventes. Todas
as nossas peças estão disponíveis neste
acabamento.

SATIN
IS OUR STANDARD FINISH
The steel is polished to achieve a matte
finish with no shining. Our matte finish
is obtained with high quality materials,
achieving a very low surface roughness
but which, however, remain non-glossy,
functioning as neutral pieces, reflecting
tenuously the surrounding tones. All our
products are available with this finish.

SATIN
ACABADO ES NUESTRO STANDARD
El acero es pulido con el fin de conseguir un
acabado mate sin brillo. El acabado mate
se logra con materiales de alta calidad, la
rugosidad superficial es muy baja pero,
sin embargo, siguen siendo de color mate,
las piezas funcionan como neutras que
reflejan de forma tenue los tonos que
le rodean. Todas nuestras piezas están
disponibles en el acabado.



.S
Aço inoxidável satinado ou escovado /
Satin or brushed stainless steel /
Acero inox satinado o cepillado.



AÇO INOXIDÁVEL POLIDO BRILHO /
MIRROR POLISHED
STAINLESS STEEL /
ACERO INOX PULIDO
BRILLO.

POLIDO
ACABAMENTO ESPECIAL
PARA AÇO INOX
Este acabamento resulta do polimento
do aço até à obtenção de superfícies
completamente lisas e brilhantes. É um
acabamento semelhante ao cromado
brilhante. As peças reflectem de forma
brilhante os tons envolventes. Algumas
das nossas peças estão disponíveis neste
acabamento. De uma forma geral, salvo
algumas excepções, todas as peças
podem ser fabricadas neste acabamento.
Existem limitações quanto ao tamanho
das peças que podem ser polidas.

MIRROR POLISHED
SPECIAL FINISH ON STAINLESS STEEL
This finish results from the polishing of the
steel until obtaining completely smooth
and shiny surfaces. It's similar to a bright
chrome finish. The pieces reflect shining
surrounding tones. Some of our pieces
are available at this finish. Generally,
with few exceptions, all fittings can be
manufactured in this finishing. There are
limitations on the size of parts that can be
mirror polished.

PULIDO BRILLO
ACABADOS ESPECIALES
EN ACERO INOXIDABLE
Este acabado resulta del pulimento del
acero hasta la obtencion de superficies
completamente lisas con brillo. Es un
acabado similar al cromo brillo. Las piezas
reflecten de forma brillante los tonos
envolvientes. Algunas de nuestras piezas
están disponibles en este acabado. De una
forma general, salvo algunas excepciones,
todas las piezas pueden ser fabricadas
en este acabado. Hay limitaciones en
el tamaño de las piezas que pueden ser
pulidas.



.P
Aço inoxidável polido brilho /
Mirror polished stainless steel /
Acero inox pulido brillo.



AÇO INOXIDÁVEL ACABAMENTO INDUSTRIAL "RAW" /
INDUSTRIAL "RAW"
STAINLESS STEEL /
ACERO INOX ACABADO
INDUSTRIAL "RAW"

RAW
ACABAMENTO ESPECIAL PARA AÇO INOX
Este acabamento é conseguido na fase
final do processo de polimento. As peças
são submetidas a um tratamento de
abrasão. O resultado final são peças
absolutamente sem brilho com uma
textura muito agradável ao tacto.
Visualmente as peças apresentam uma
coloração cinza, parecida com betão,
dando uma imagem de peças
industriais, como se fossem
ferramentas.
Todas as nossas peças podem ser
fabricadas com este acabamento,
existe, contudo, uma limitação quanto
ao comprimento máximo de 600mm.

RAW
SPECIAL FINISH ON STAINLESS STEEL
This finish is achieved in the final phase
of the polishing process. The parts are
subjected to a treatment of abrasion. The
end result is absolutely dull pieces with a
very nice texture to be touched. Visually,
the pieces have a grey concrete like color,
giving the image of industrial parts, like they were
tools. All our parts can be manufactured in
this finish, however there is a limit on the
maximum length of 600 mm.

RAW
ACABADOS ESPECIALES
EN ACERO INOXIDABLE
Este acabado se consigue en la fase
final del proceso de pulido. Las partes se
someten a un tratamiento de abrasión. El
resultado final es de piezas absolutamente
sin brillo, con una textura muy agradable
al tacto. Visualmente las piezas tienen un
color gris, al igual que lo concreto, dando
a las piezas una imagen industrial como
si fueran herramientas. Todas nuestras
piezas pueden ser fabricadas en este
acabado, sin embargo hay un límite en la
longitud máxima de 600mm.

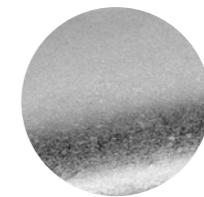

.RAW
Aço inoxidável acabamento industrial "raw" /
Industrial "raw" stainless steel /
Acero inox acabado industrial "raw"

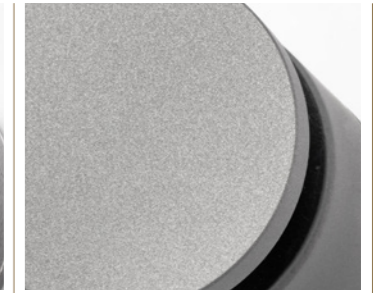

AÇO INOXIDÁVEL ACABAMENTO JET
STAINLESS STEEL JET FINISH /
ACERO INOX ACABADO JET /

JET
ACABAMENTO ESPECIAL PARA AÇO INOX
Este acabamento é conseguido na fase
final do processo de polimento. As peças
são submetidas a um tratamento de
projeção de partículas de vidro.
O resultado final são peças de cor
cinza mate uniforme, com uma textura
agradável ao tacto. Visualmente, as
peças apresentam uma coloração
discreta perfeitamente adequada a
ambientes onde não se pretendem
brilhos metálicos.
As peças resultantes integram-se em
qualquer tipo de decoração. Todas as
nossas peças podem ser fabricadas
com este acabamento, existe contudo
uma limitação quanto ao comprimento
máximo de 600mm.

JET
SPECIAL FINISH ON STAINLESS STEEL
This finish is achieved in the final phase
of the polishing process. The parts are
subjected to a treatment with projection
of glass particles. The final result are
pieces of uniform matte grey color with
a nice texture to be touched. Visually,
the pieces have a slight coloring, perfectly
suited to environments where no metallic
glare is desired. The resulting pieces are
completely discreet and integrate in any
type of decoration. All our parts can be
manufactured in this finish, however there is
a limit on the maximum length of 600mm.

JET
ACABADOS ESPECIALES
EN ACERO INOXIDABLE
Este acabado se consigue en la fase
final del proceso de pulido. Las partes se
someten a un tratamiento de proyección
de partículas de cristal. El resultado
final son piezas de color uniforme gris
mate con una textura agradable al tacto.
Visualmente, las piezas tienen un color
discreto que se adapta perfectamente a
entornos en los que el brillo metálico no
es adecuado. Las piezas resultantes se
quedan perfectamente integradas en el
entorno. Todas nuestras piezas pueden ser
fabricadas en este acabado, sin embargo
hay un límite en longitud máx.de 600mm.

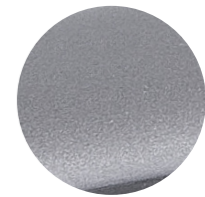

.JET
Aço inoxidável acabamento jet
Stainless steel jet finish /
Acero inox acabado jet /

ACABAMENTOS EM TITANIUM PVD

PVD TITANIUM FINISHES IN STAINLESS STEEL —
— ACABADOS EN TITANIO PVD EN ACERO INOXIDABLE

ACABAMENTOS ESPECIAIS DO AÇO INOX REVESTIDO A TITÂNIO

Este acabamento é conseguido pela tecnologia PVD (Physical Vapor Deposition). É um processo não galvânico, não poluente, amplamente utilizado na indústria da relojoaria.

Trata-se dum acabamento de excepcional qualidade, conferindo ao produto final uma dureza adicional e uma resistência à corrosão elevadíssima. As nossas peças podem ser fabricadas neste acabamento. A medida máxima das peças nestes acabamentos é de 1000mm.

SPECIAL FINISH ON STAINLESS STEEL TITANIUM COATED

This finish is achieved by PVD technology (Physical Vapor Deposition). It is a non galvanic, pollution free process, widely used in the watchmaking industry. This is an exceptionally high quality finish, giving the final product an additional hardness and a very high corrosion resistance. Our products can be manufactured in this finish. The maximum length of the parts on this finish is 1000mm.

ACABADOS ESPECIALES EN ACERO INOXIDABLE REVESTIDO A TITANIO

Este acabado se consigue mediante la tecnología PVD (Physical Vapor Deposition). Es un proceso no galvánico, no poluente, ampliamente utilizado en la industria de la relojería.

Este es un acabado de calidad excepcionalmente alta, dando el producto final una dureza adicional y una resistencia a la corrosión muy alta. Nuestras piezas se pueden fabricar en el acabado. La longitud máxima de las piezas en estos acabados es de 1000mm.

PVD TITANIUM FINISHES IN STAINLESS STEEL —
— ACABADOS EN TITANIO PVD EN ACERO INOXIDABLE

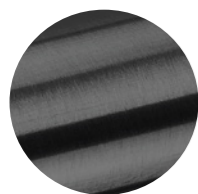

.TB

TITANIUM BLACK

Aço inoxidável + pvd titânio preto /
Stainless steel + pvd titanium black /
Acero inox + pvd titânio negro.

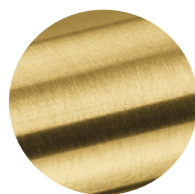

.TG

TITANIUM GOLD

Aço inoxidável + pvd titânio dourado /
Stainless steel + pvd titanium gold /
Acero inox + pvd titânio dorado.

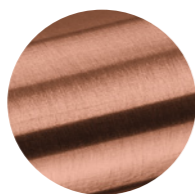

.TCO

TITANIUM COPPER

Aço inoxidável + pvd titânio cobre /
Stainless steel + pvd titanium copper /
Acero inox + pvd titânio cobre.

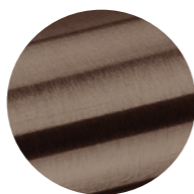

.TCH

TITANIUM CHOCOLATE

Aço inoxidável + pvd titânio chocolate /
Stainless steel + pvd titanium chocolate /
Acero inox + pvd titânio chocolate.



.TN

TITANIUM NATURAL

Aço inoxidável + pvd titânio /
Stainless steel + pvd titanium /
Acero inox + pvd titânio.

ACABAMENTOS EM TITÂNIO PVD ENVELHECIDO —
— PVD TITANIUM FINISHES AGED — ACABADOS EN TITANIO PVD ENVEJECIDO

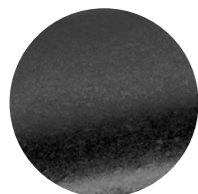

.TCB

TITANIUM COAL BLACK

Aço inoxidável RAW + pvd titânio preto /
RAW stainless steel + pvd titanium black /
Acero inox RAW + pvd titânio negro.

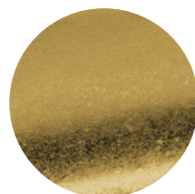

.TAG

TITANIUM AGED GOLD

Aço inoxidável RAW + pvd titânio dourado /
RAW stainless steel + pvd titanium gold /
Acero inox RAW + pvd titânio dorado.

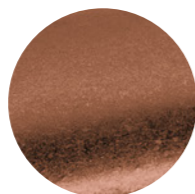

.TAC

TITANIUM AGED COPPER

Aço inoxidável RAW + pvd titânio cobre /
RAW stainless steel + pvd titanium copper /
Acero inox RAW + pvd titânio cobre.

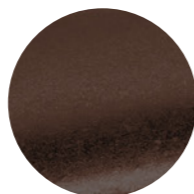

.TAB

TITANIUM AGED BRONZE

Aço inoxidável RAW + pvd titânio bronze /
RAW stainless steel + pvd titanium bronze /
RAW Acero inox + pvd titânio bronze.

PVD TITANIUM FINISHES IN STAINLESS STEEL —
— ACABADOS EN TITANIO PVD EN ACERO INOXIDABLE

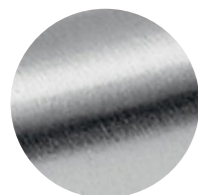

**MICRO™
SAFE**

.TMS

JNF MICROSAFE™

Aço inoxidável + MICROsafe™ antimicrobial /
Stainless steel + MICROsafe™ antimicrobial /
Acero inox + MICROsafe™ antimicrobial.

FINISH ON
STAINLESS STEEL

TITANIUM



JNF MICROSAFE A SOLUÇÃO ANTIMICROBIANA

JNF MICROSAFE THE ANTIMICROBIAL SOLUTION
— JNF MICROSAFE LA SOLUCIÓN ANTIMICROBIANA



ANTIMICROBIAL

Revestimento de superfície com propriedade anti microbial / Surface coating with anti microbial property / Revestimiento de superficie con propiedad antimicrobiana.



ANTIMICROBIAL

Ao uso de elementos antimicrobianos comprovadamente eficazes, como a prata e o cobre, damos-lhe um nome comercial: MICROsafe™ mas não tem segredo, são os elementos naturais antimicrobianos mais antigos do mundo. A técnica é a única receita para a sua eficácia: nano partículas de prata e cobre depositadas na superfície das nossas peças.

O tratamento JNF MICROsafe™ é certificado pelo laboratório Alemão HOHENSTEIN.

JNF MICROsafe™ usa a nano tecnologia com partículas de prata depositada na superfície dos nossos produtos.

Este tratamento superficial confere propriedades permanentes antimicrobianas aos produtos onde é aplicada sendo a sua acção eficaz ao longo do tempo não necessitando manutenção.

A prata e o cobre sofrem processos de oxidação natural, conferindo à superfície onde são aplicados uma tonalidade ligeiramente mais escura, no entanto a sua eficácia não é alterada nem esta modificação de tonalidade significa qualquer defeito no tratamento.

Using proven antimicrobial elements, such as silver and copper, we give it a trade name: MICROsafe™, but there is no secret, they are the oldest natural antimicrobial elements in the world. The technique is the only recipe for its effectiveness: nano particles of silver and copper deposited on the surface of our pieces.

The JNF MICROsafe™ treatment is certified by the German HOHENSTEIN laboratory.

JNF MICROsafe™ uses nano technology with silver particles deposited on the surface of our products.

This surface treatment imparts permanent antimicrobial properties to the products where it is applied and its action is effective over time and does not require maintenance.

Silver and copper undergo a natural oxidation process, giving the surface where is applied a slightly darker shade, however its effectiveness is not altered nor does this shade change mean any defect in the treatment.

Usando elementos antimicrobianos probados, como prata y cobre, le damos un nombre comercial: MICROsafe™, pero no hay ningún secreto, son los elementos antimicrobianos naturales más antiguos del mundo. La técnica es la única receta de su eficacia: nanopartículas de plata y cobre depositadas sobre la superficie de nuestras piezas.

El tratamiento JNF MICROsafe™ está certificado por el laboratorio Alemán HOHENSTEIN.

JNF MICROsafe™ utiliza nanotecnología con partículas de plata depositadas en la superficie de nuestros productos.

Este tratamiento superficial confiere propiedades antimicrobianas permanentes a los productos donde se aplica y su acción es efectiva en el tiempo y no requiere mantenimiento.

La plata y el cobre se someten a un proceso de oxidación natural, dando a la superficie donde se aplica una tonalidad ligeramente más oscura, sin embargo su efectividad no se altera ni este cambio de tonalidad supone ningún defecto en el tratamiento.

HOHENSTEIN

Zertifikat

Antibakterielle Aktivität | Z-297159

JNF, S.A.
Rua das Mimosas 849/851 | S. Pedro da Cova | 4424-909 Gondomar | Portugal

Samples AB20 PVD coated antibacterial
AB21 PVD coated antibacterial

Gemäß Bericht Nr. 20.8.3.0356 vom 18. Dezember 2020 wird bestätigt, dass oben genannter Artikel, geprüft und bewertet von der Hohenstein Laboratories GmbH & Co. KG nach ISO 22196:2011-08 "Kunststoffe - Messung von antibakterieller Aktivität auf Kunststoffoberflächen", eine antibakterielle Aktivität gegen die Testkeime *Staphylococcus aureus* ATCC 6538P und *Escherichia coli* ATCC 8739 aufweisen.

Das Zertifikat ist gültig bis 31. Dezember 2021.

Dr. Timo Hammer
Chief Executive Officer

Hohenstein Laboratories GmbH & Co. KG | Schlosssteige 1 | 74857 Bönnigheim | Germany

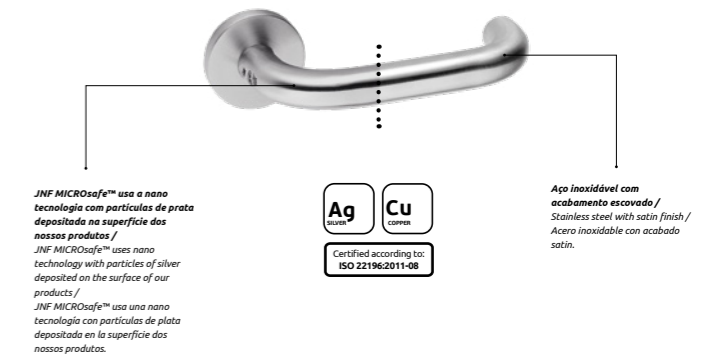

A TECNOLOGIA JNF MICROsafe™ REDUZ O CRESCIMENTO MICROBIANO EM 99,9% NAS SUPERFÍCIES ONDE É APLICADO.



JNF MICROsafe™
ANTIMICROBIAL
Certified according to: ISO 22196:2011-08

JNF MICROsafe™ TECHNOLOGY REDUCES MICROBIAL GROWTH BY 99.9% ON SURFACES WHERE APPLIED.

LA TECNOLOGÍA JNF MICROsafe™ REDUCE EL CRECIMIENTO MICROBIANO EN UN 99,9% EN LAS SUPERFICIES DONDE SE APLICA.

PRIREV
SURFACE TECHNOLOGY
Tecnologia desenvolvida por PRIREV
Technology developed and performed by PRIREV
Tecnología desarrollada y ejecutada por PRIREV

JNF AROUND THE WORLD

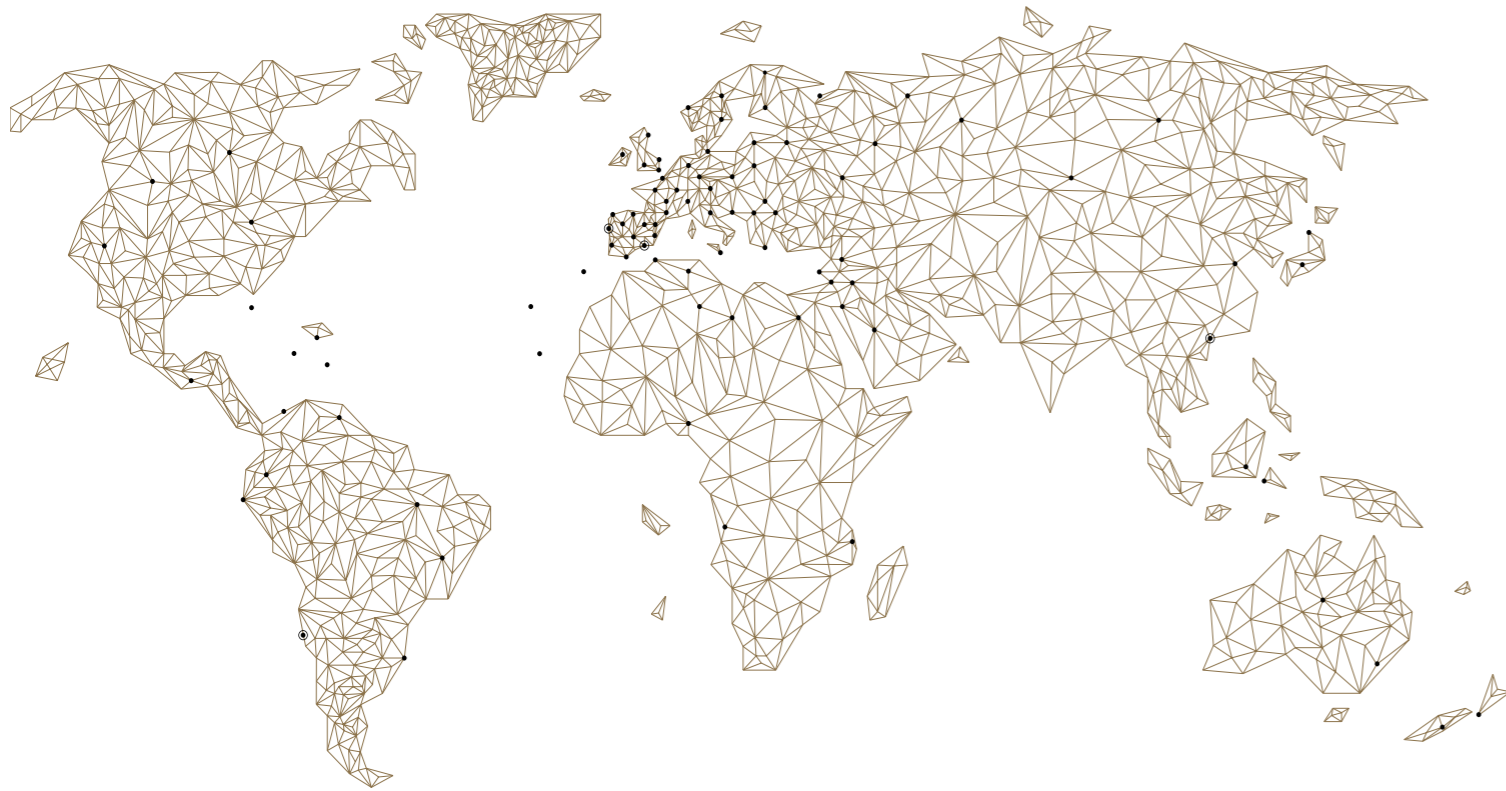

VENDEMOS EM MAIS DE 100 PAÍSES, CONTAMOS MUITOS CLIENTES COM SHOWROOM E FORMAÇÃO DE PRODUTO JNF EM DIFERENTES PAÍSES. TEMOS MUITOS REPRESENTANTES DA MARCA COM CAPACIDADE DE RESPOSTA IMEDIATA.

WE SELL IN MORE THAN 100 COUNTRIES, WE HAVE MANY CUSTOMERS WITH JNF PRODUCT TRAINING SHOWROOM IN DIFFERENT COUNTRIES. WE HAVE MANY BRAND REPRESENTATIVES WITH IMMEDIATE RESPONSE CAPACITY.

VENDEMOS EN MÁS DE 100 PAÍSES, TENEMOS MUCHOS CLIENTES CON SHOWROOM DE CAPACITACIÓN DE PRODUCTOS JNF EN DIFERENTES PAÍSES, TENEMOS MUCHOS REPRESENTANTES DE MARCAS CON CAPACIDAD DE RESPUESTA INMEDIATA.



JNF PORTUGAL

Head office / Factory

Comércio e Indústria de Ferragens S.A.
Rua Mimosas 849 / 851,
Zona Industrial Mimosas
4510-329 Gondomar, Portugal

Tel: +351 224 663 230
jnf@jnf.pt
www.jnf.pt

JNF SPAIN

Office / Showroom

JNFmyStore
Carrer Bruc, 77 Local dch.
08009 Barcelona

Tel: +34 932 504 047
Fax: +34 934 674 500
jnf@jnfmystore.es
www.jnfmystore.es

**AS ESPECIFICAÇÕES DOS PRODUTOS CONTIDOS
NESTES CATÁLOGOS PODEM SER ALTERADOS
SEM AVISO PRÉVIO.**

*The technical specifications of the products
contents in this catalogue can be changed without
any previous advise. / Las especificaciones
técnicas de los productos contenidos en este
catalogo pueden ser cambiadas sin previo aviso.*

**A REPRODUÇÃO INTEGRAL OU PARCIAL
DESTE CATÁLOGO NÃO É PERMITIDA.**

*The integral or partial copy of this catalogue is not
allowed. La copia integral o parcial deste catalogo
no es permitida.*

**TODAS AS MEDIDAS DESTE CATÁLOGO
ESTÃO EM MILÍMETROS.**

*All the dimensions in this catalogue are
in millimeters / Todas las dimensiones en este
catalogo estan en milímetros.*

CT-24.02.0

**ALWAYS
MORE**

59 YEARS
1965.2024





ARCHITECTURAL
HARDWARE

**ALWAYS
MORE**



ISO 9001
ISO 14001
ISO 45001



RECOGNIZED
CERTIFICATION

